



# GEOTUB PANEL



**MANUALE TECNICO**   
**TECHNICAL MANUAL** 

## CONTENTS

PAG. 2	LIST OF COMPONENTS - LISTA COMPONENTI
PAG. 3	COLUMN COMBINATIONS - CONBINAZIONI COLONNA
PAG. 4	COLUMN ASSEMBLING [A] - ASSEMBLAGGIO COLONNA [A]
PAG. 6	COLUMN ASSEMBLING [B] - ASSEMBLAGGIO COLONNA [B]
PAG. 8	COLUMN ASSEMBLING [C] - ASSEMBLAGGIO COLONNA [C]
PAG. 10	FIXING TO THE GROUND - FISSAGGIO A TERRA
PAG. 11	COLUMN PROPPING [1] - PUNTELLAZIONE COLONNA [1]
PAG. 11	COLUMN PROPPING [2] - PUNTELLAZIONE COLONNA [2]
PAG. 12	COLUMN DISMANTLING - DISARMO COLONNA
PAG. 13	POUR GUIDELINES - PRESCRIZIONI DI GETTO
PAG. 15	OPERATION AND MAINTENANCE REQUIREMENTS - PRESCRIZIONI DI USO E MANUTENZIONE
PAG. 15	SAFETY REQUIREMENTS - PRESCRIZIONI DI SICUREZZA

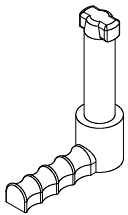
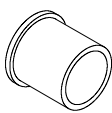
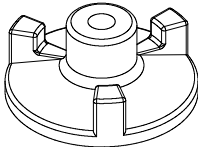
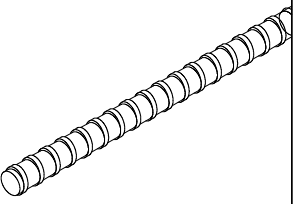
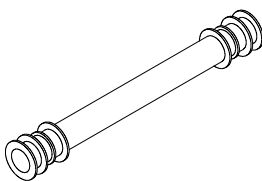
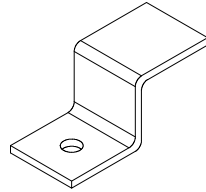
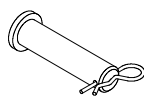
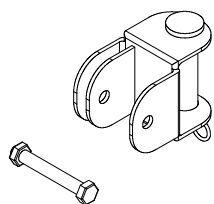
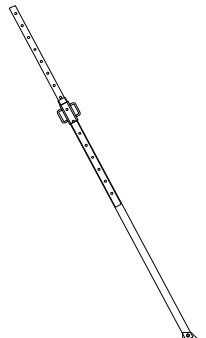
					
HANDLE	MANIGLIA	CAP Ø 25mm	TAPPO Ø 25mm	ANCHOR NUT Ø 120mm	ROSETTA Ø 120mm
					
TIE ROD	BARRA RULLATA	SPACER	DISTANZIATORE	FIXING BRACKET	STAFFA D'ANCORAGGIO
					
PIN Ø 24 WITH R-CLIP	PERNO Ø 24 CON COIGLIA	BRACE CONNECTOR AND M12 BOLT	NODO STABILIZZATORE E BULLONE M12	PUSH \ PULL PROP	PUNTELLO TIRA \ SPINGI

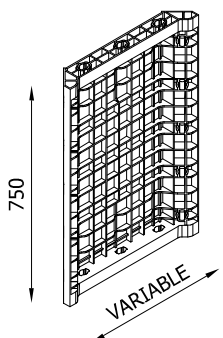
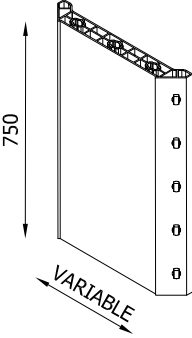
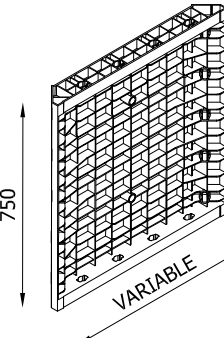
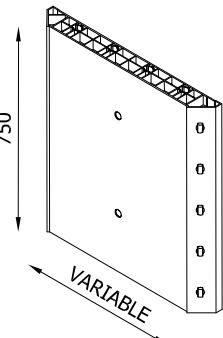
GEOTUB PANEL 20 - 25 - 30 - 35 - 40		GEOTUB PANEL 45 - 50 - 55 - 60	
			
EXTERNAL VIEW VISTA ESTERNA	INTERNAL VIEW VISTA INTERNA	EXTERNAL VIEW VISTA ESTERNA	INTERNAL VIEW VISTA INTERNA

IT IS POSSIBLE TO REALIZE 55 COLUMN COMBINATIONS WITH GEOTUB PANEL ELEMENTS, BASED ON 3 DIFFERENT ASSEMBLING METHODS (A, B, C), AS SHOWN IN THE FOLLOWING TABLE:

E' POSSIBILE REALIZZARE 55 COMBINAZIONI DI COLONNA CON ELEMENTI GEOTUB PANEL, BASATE SU 3 DIVERSI METODI DI ASSEMBLAGGIO (A, B, C), COME MOSTRATO NELLA TABELLA SUCCESSIVA:

COLUMN SIZE		COLUMN SIZE										
		[cm]	20	23	25	30	35	40	45	50	55	60
COLUMN SIZE	20	A	A	A	A	A	A	A	B	B	B	B
	23		A	A	A	A	A	A	B	B	B	B
	25			A	A	A	A	A	B	B	B	B
	30				A	A	A	A	B	B	B	B
	35					A	A	A	B	B	B	B
	40						A	A	B	B	B	B
	45								C	C	C	C
	50									C	C	C
	55										C	C
	60											C

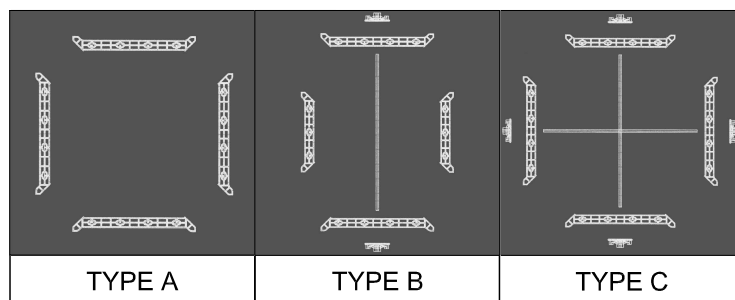



1. FIRST COLUMN CORNER INSTALLATION  
 INSTALLAZIONE PRIMO ANGOLO DELLA COLONNA

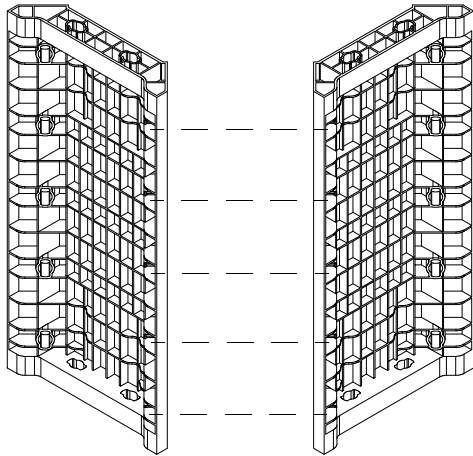

2. GEOTUB PANEL ELEMENTS FIXING WITH HANDLES  
 FISSAGGIO ELEMENTI GEOTUB PANEL CON MANIGLIE

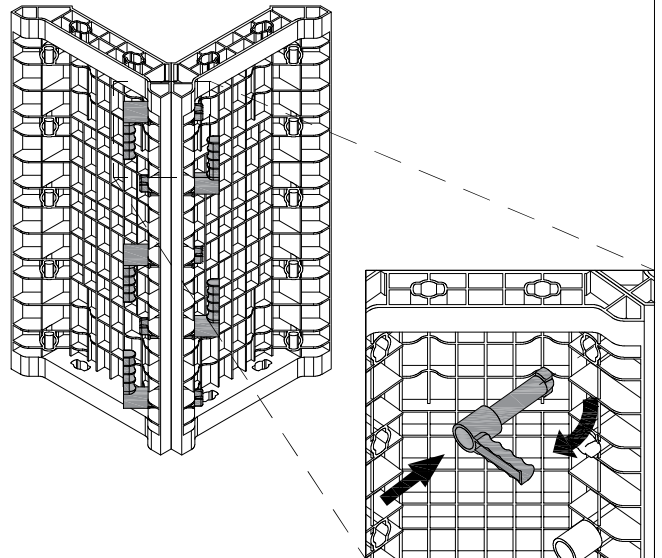

3. SECOND COLUMN CORNER INSTALLATION  
 INSTALLAZIONE SECONDO ANGOLO DELLA COLONNA

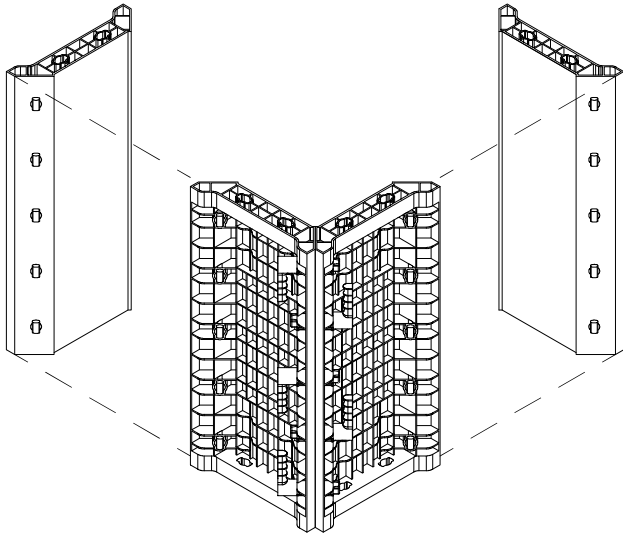

4. SECOND LEVEL OF GEOTUB PANEL ASSEMBLING  
 ASSEMBLAGGIO SECONDO LIVELLO GEOTUB PANEL

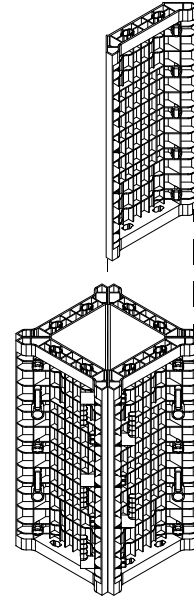

5. GEOTUB PANEL ELEMENTS FIXING WITH HANDLES  
 FISSAGGIO ELEMENTI GEOTUB PANEL CON MANIGLIE

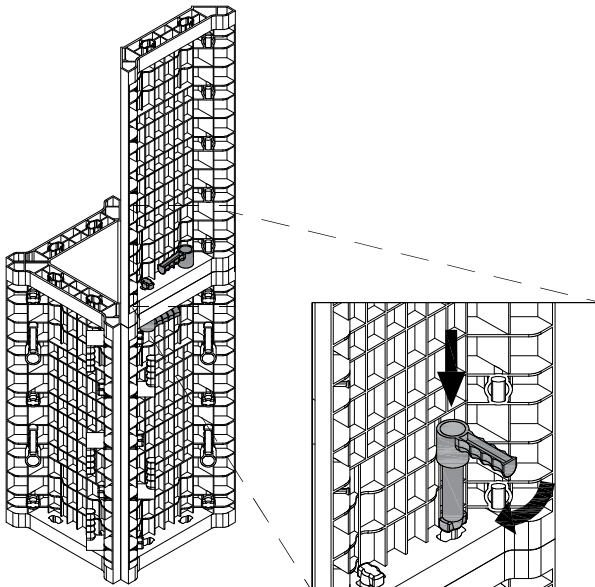

6. SECOND LEVEL OF GEOTUB ASSEMBLING  
 ASSEMBLAGGIO SECONDO LIVELLO GEOTUB

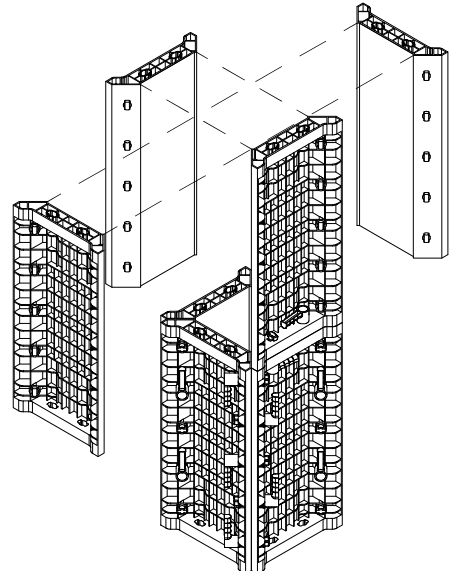

FINAL RESULT

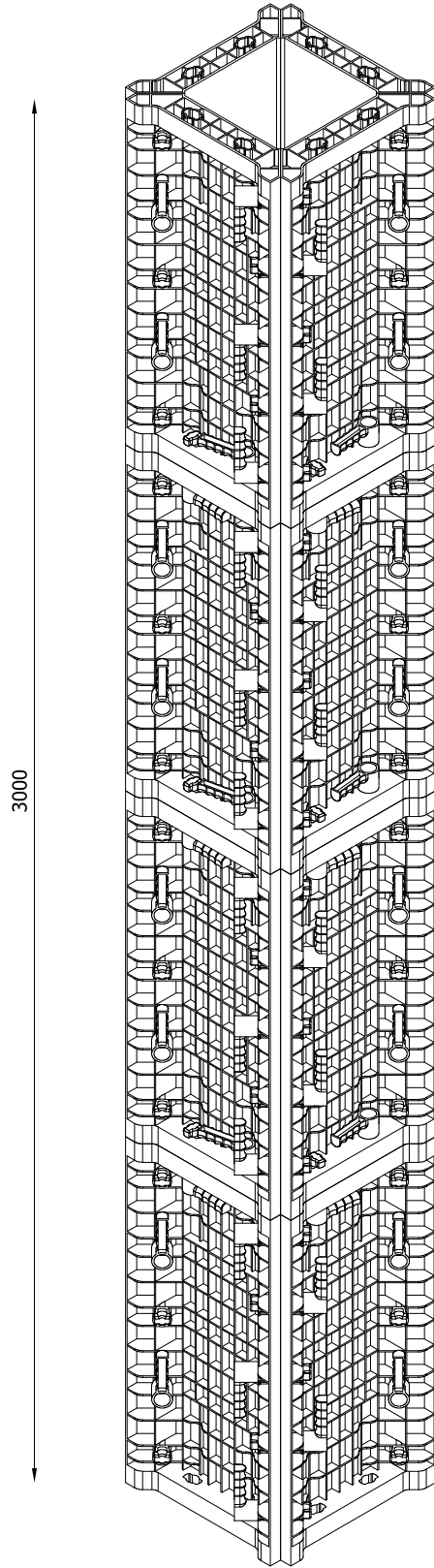

1. FIRST COLUMN CORNER INSTALLATION  
 INSTALLAZIONE PRIMO ANGOLO DELLA COLONNA

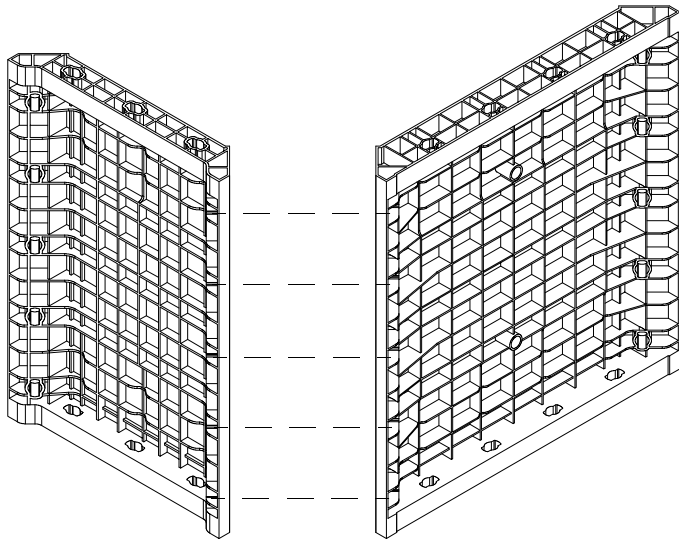

2. GEOTUB PANEL ELEMENTS FIXING WITH HANDLES  
 FISSAGGIO ELEMENTI GEOTUB PANEL CON MANIGLIE

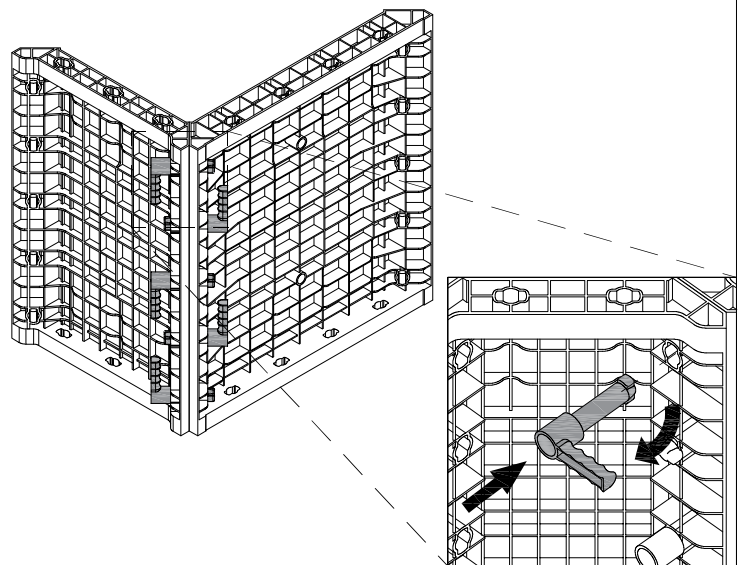

3. TIE RODS AND SPACERS INSTALLATION  
 INSTALLAZIONE BARRE RULLARE E DISTANZIATORI

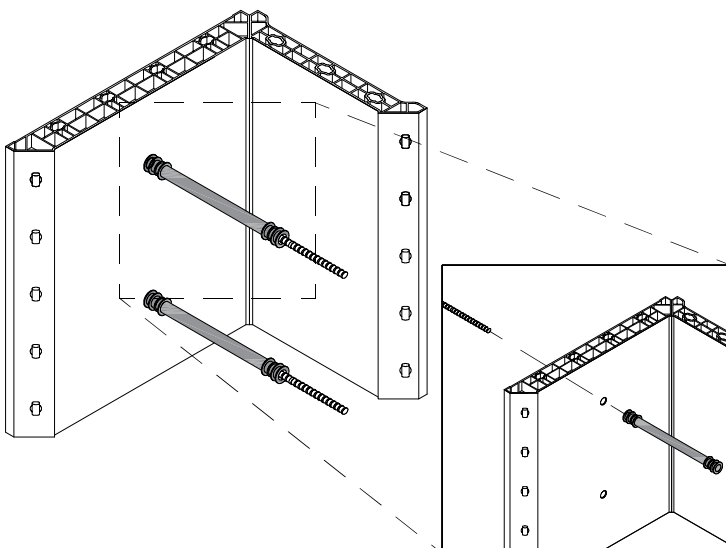

4. SECOND COLUMN CORNER INSTALLATION  
 INSTALLAZIONE SECONDO ANGOLO DELLA COLONNA

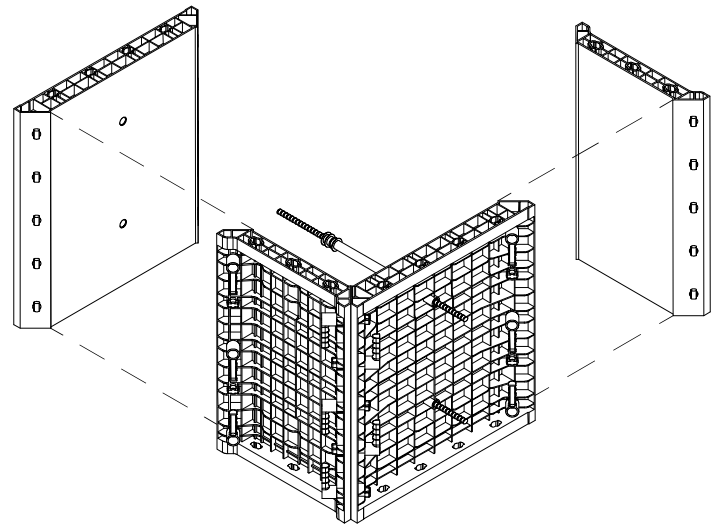

5. SECOND LEVEL OF GEOTUB PANEL ASSEMBLING  
 ASSEMBLAGGIO SECONDO LIVELLO GEOTUB PANEL

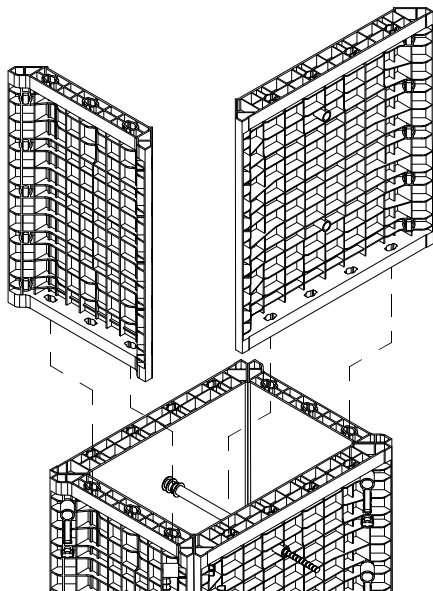

6. GEOTUB PANEL ELEMENTS FIXING WITH HANDLES  
 FISSAGGIO ELEMENTI GEOTUB PANEL CON MANIGLIE

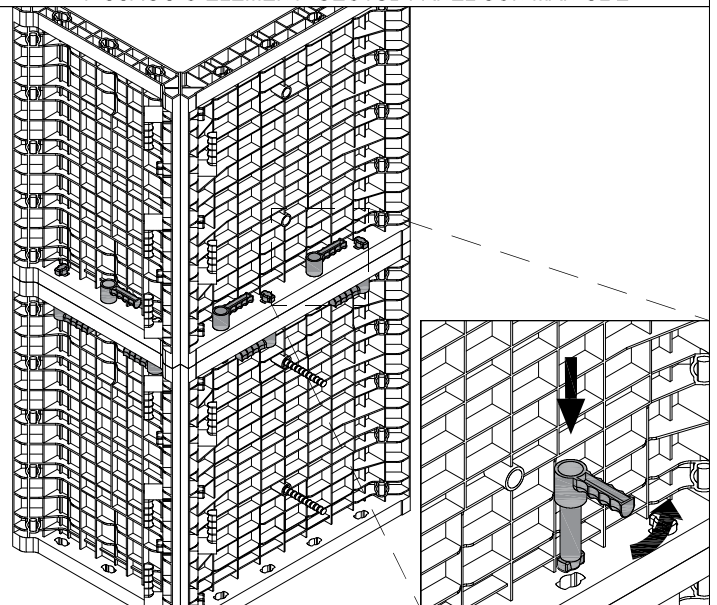

7. CAPS Ø25 INSTALLATION ON THE UPPER PANELS  
INSTALLAZIONE TAPPI Ø25 NEI PANNELLI SUPERIORI

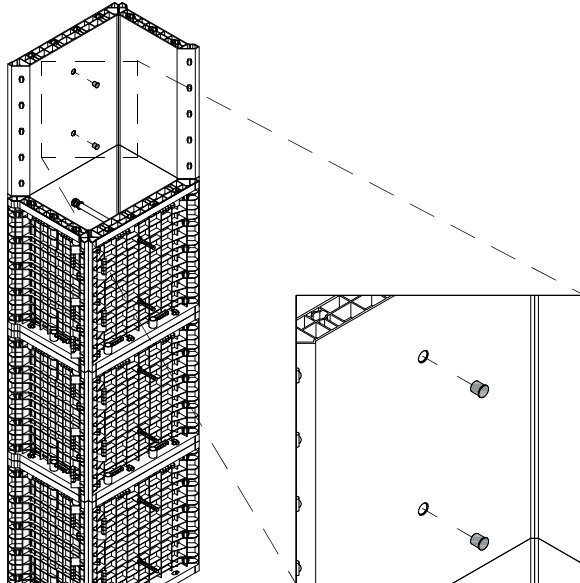

8. ANCHOR NUTS INSTALLATION  
INSTALLAZIONE ROSETTE

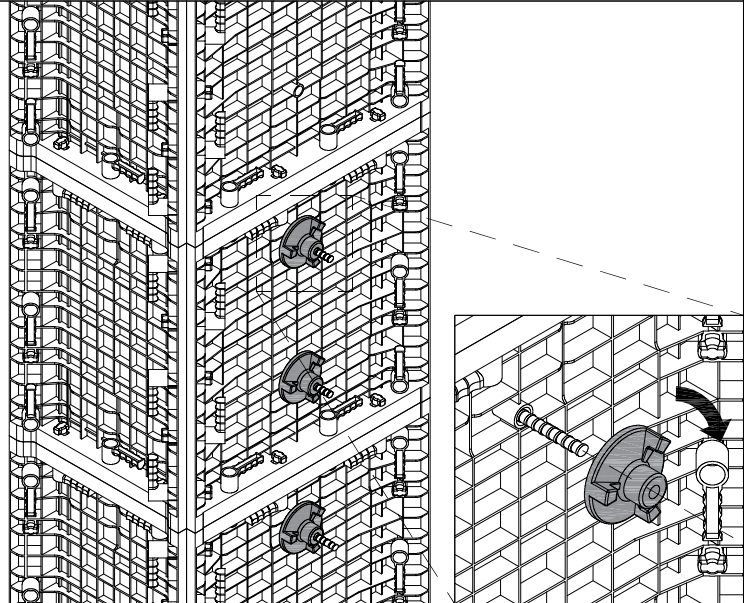

FINAL RESULT

3000

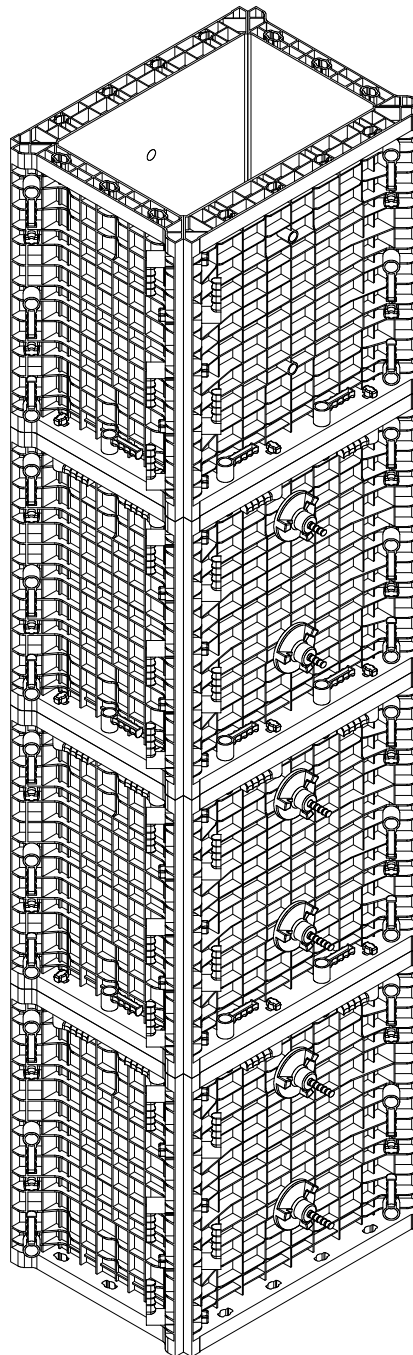



1. FIRST COLUMN CORNER INSTALLATION  
 INSTALLAZIONE PRIMO ANGOLO DELLA COLONNA

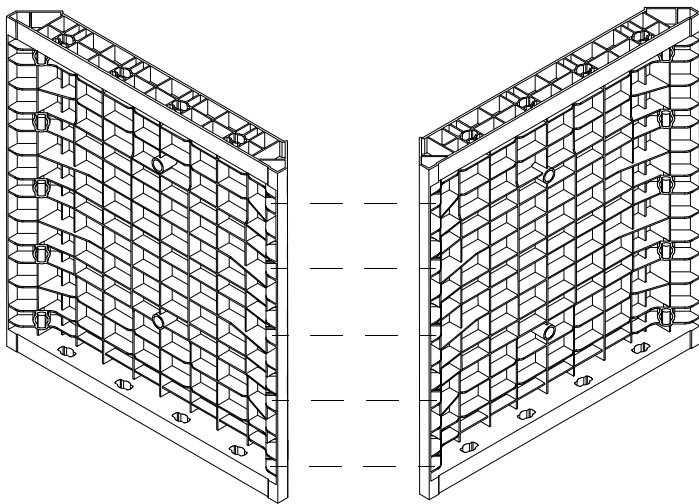

2. GEOTUB PANEL ELEMENTS FIXING WITH HANDLES  
 FISSAGGIO ELEMENTI GEOTUB PANELCON MANIGLIE

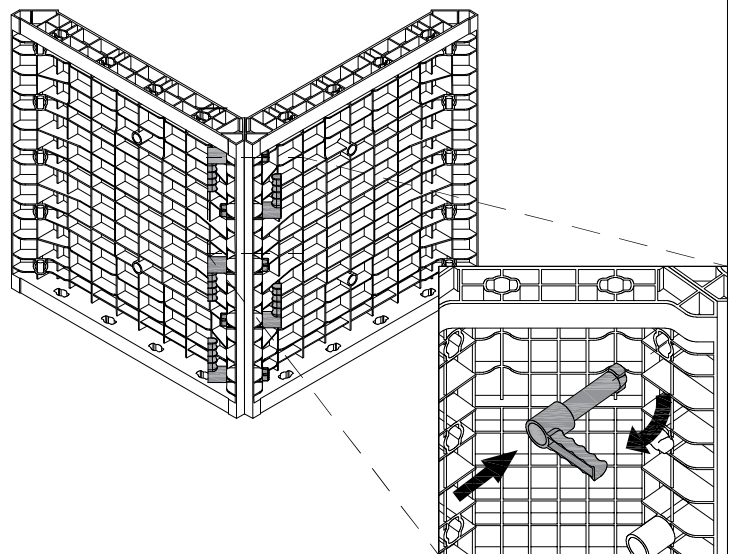

3. TIE RODS AND SPACERS INSTALLATION  
 INSTALLAZIONE BARRE RULLARE E DISTANZIATORI

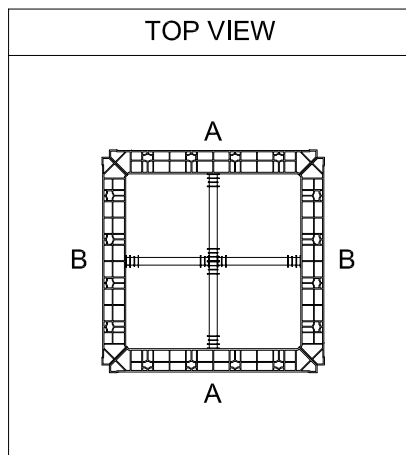
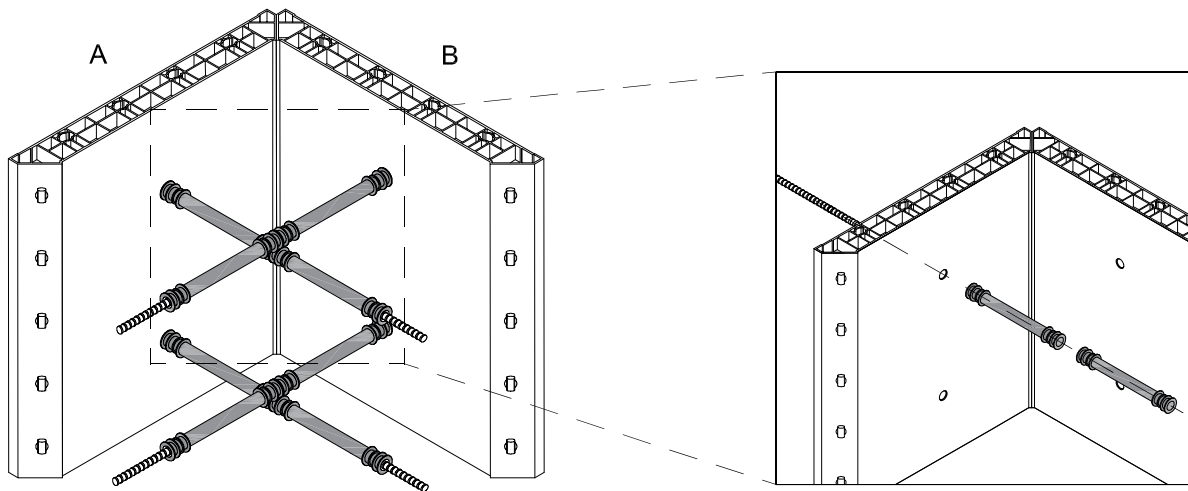

"A" POSITION

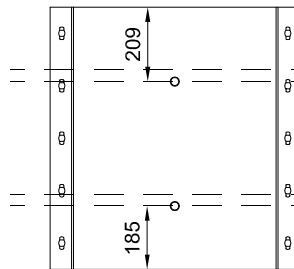

"B" POSITION

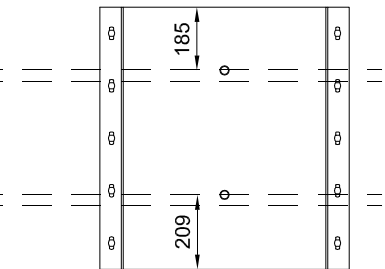

4. SECOND COLUMN CORNER INSTALLATION  
 INSTALLAZIONE SECONDO ANGOLO DELLA COLONNA

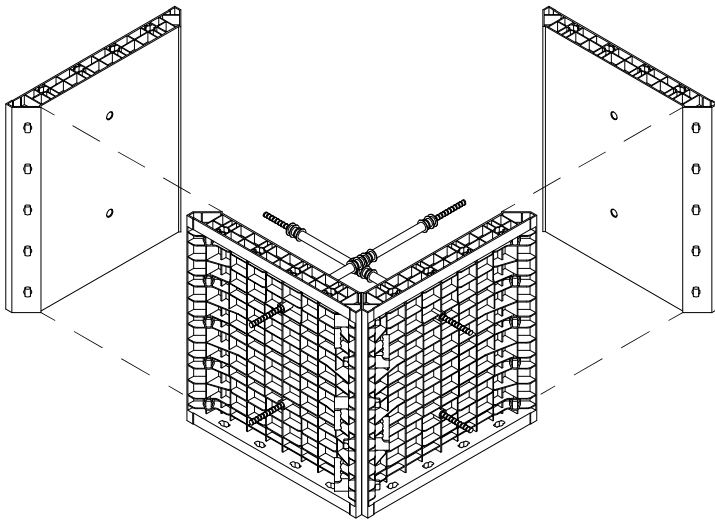

5. SECOND LEVEL OF GEOTUB PANEL ASSEMBLING  
 ASSEMBLAGGIO SECONDO LIVELLO GEOTUB PANEL

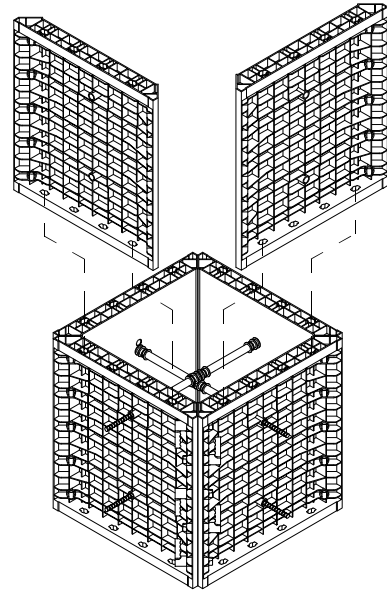

6. GEOTUB PANEL ELEMENTS FIXING WITH HANDLES  
 FISSAGGIO ELEMENTI GEOTUB PANEL CON MANIGLIE

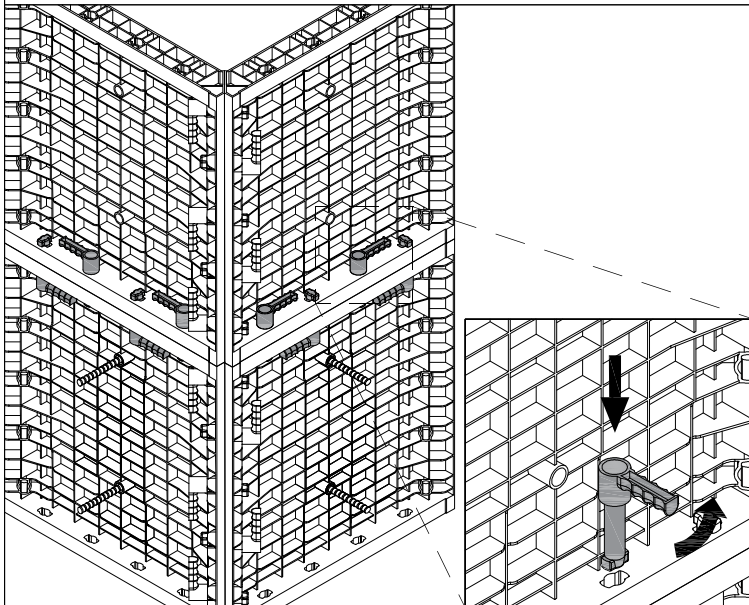

7. CAPS Ø25 INSTALLATION ON THE UPPER PANELS  
 INSTALLAZIONE TAPPI Ø25 NEI PANNELLI SUPERIORI

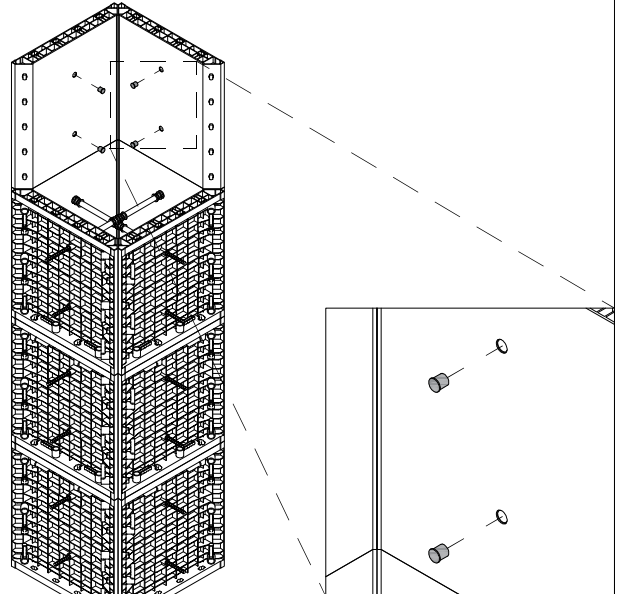

8. ANCHOR NUTS INSTALLATION  
 INSTALLAZIONE ROSETTE

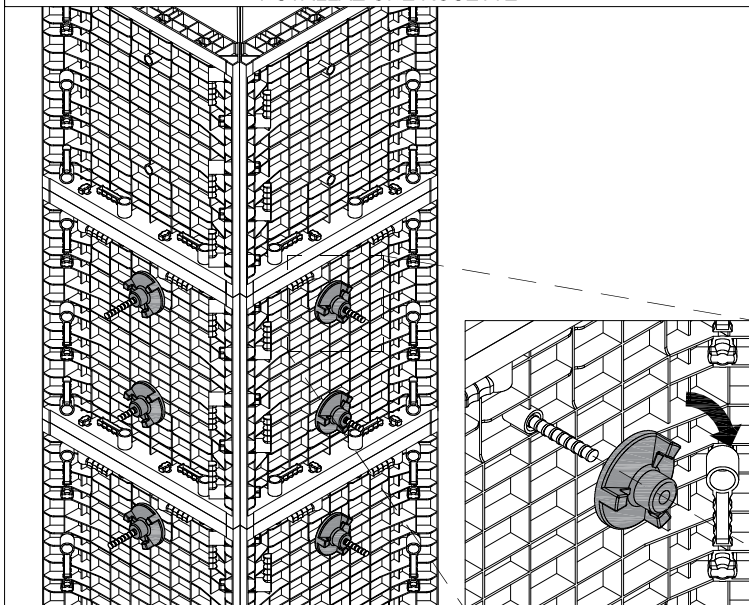



FINAL RESULT

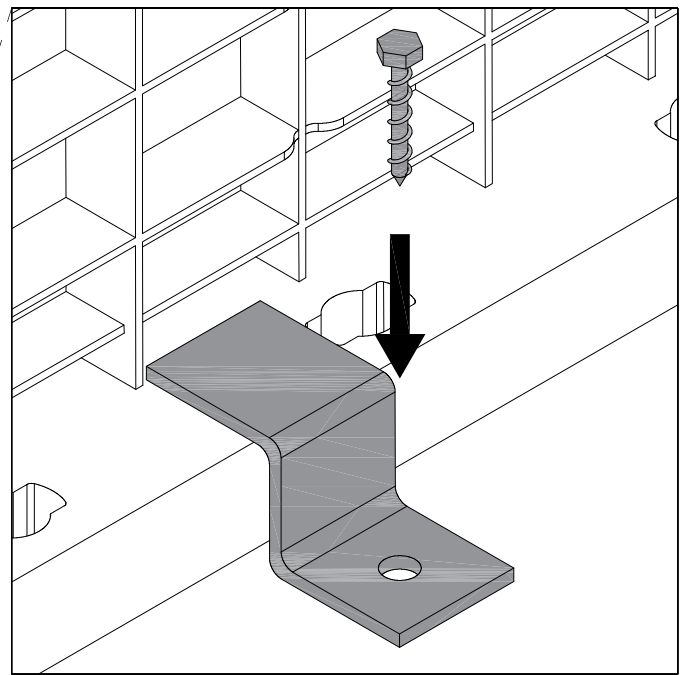
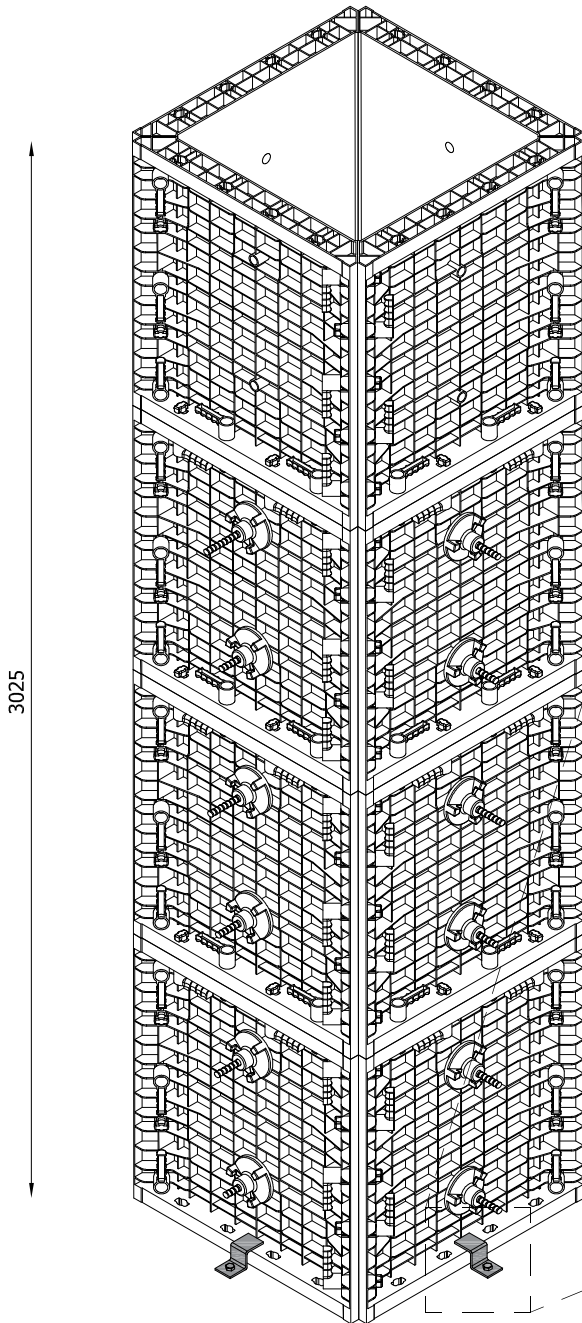

# COLUMN PROPPING [1]

# PUNTELLAZIONE COLONNA [1]

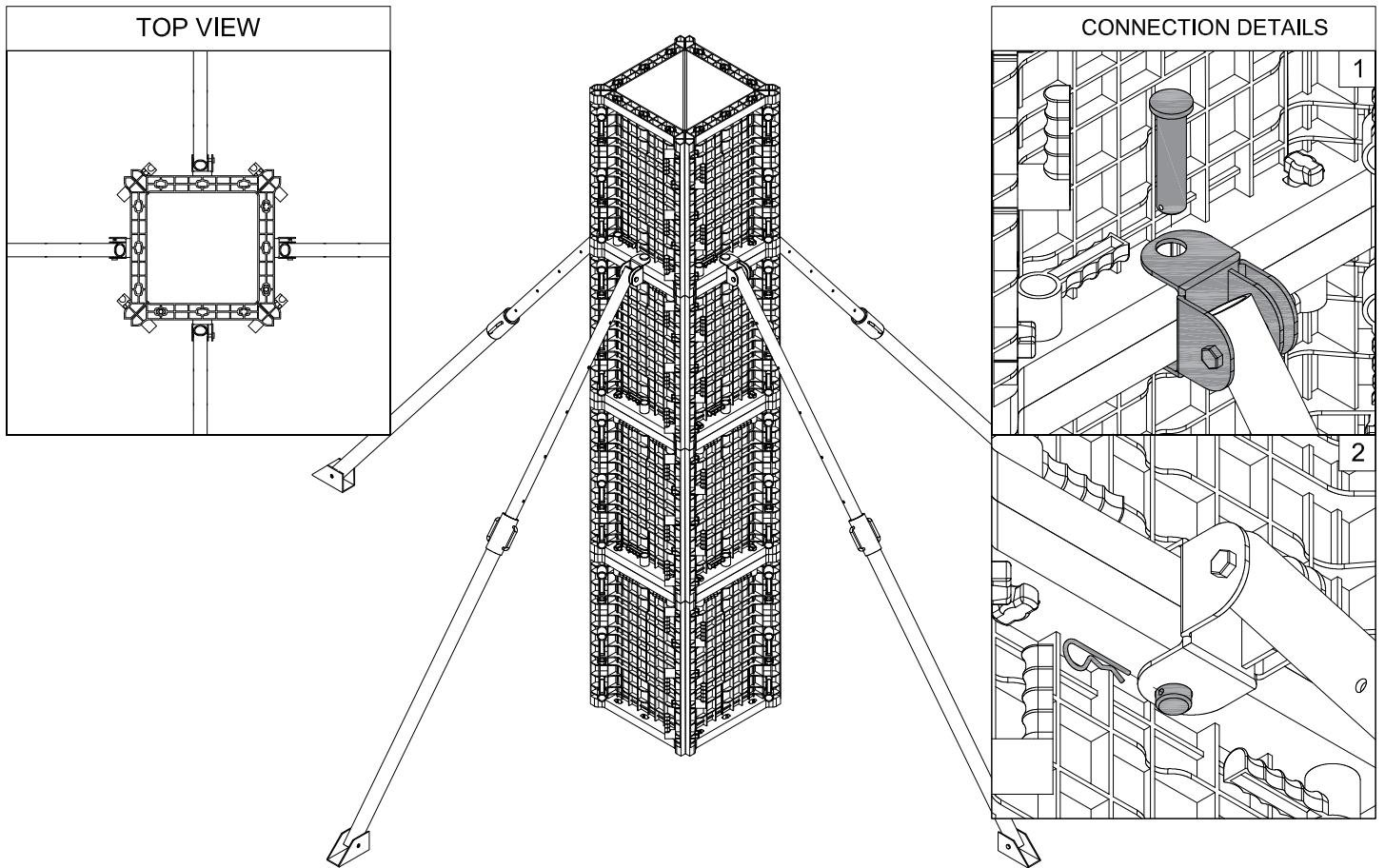

# COLUMN PROPPING [2]

# PUNTELLAZIONE COLONNA [2]

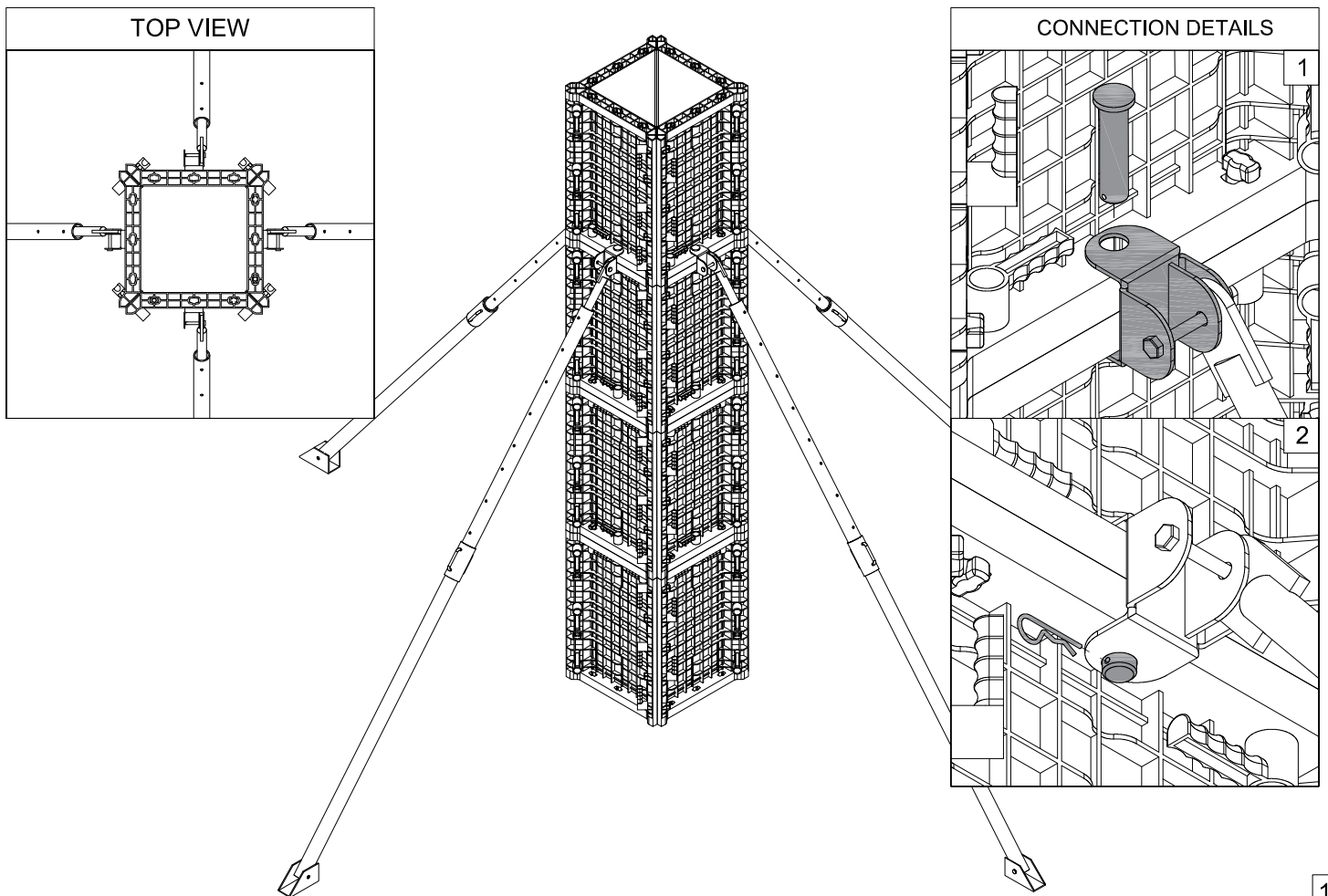

1. VERTICAL HANDLES REMOVING  
RIMOZIONE MANIGLIE VERTICALI

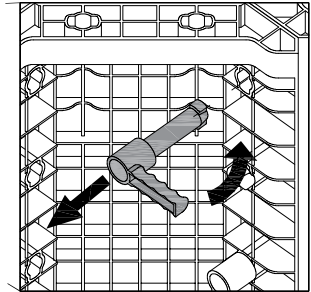
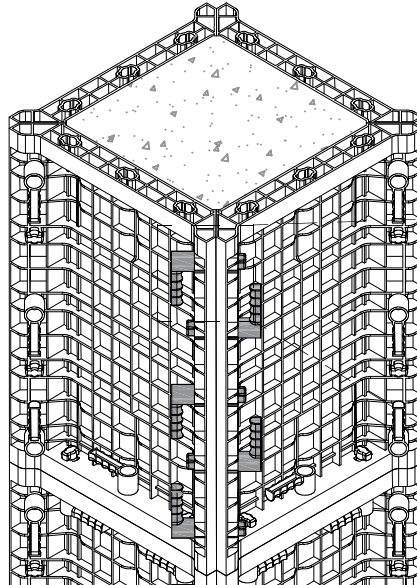
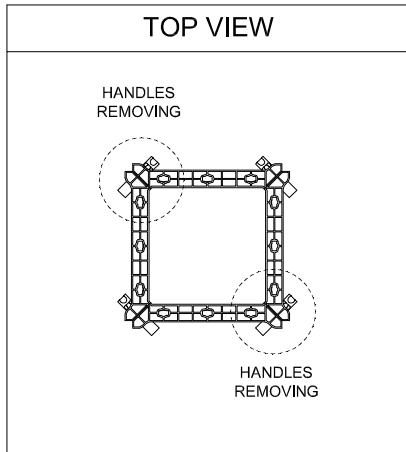

2. GEOTUB PANEL REMOVING  
RIMOZIONE GEOTUB PANEL

IT IS POSSIBLE TO MOVE HALF COLUMN FORMWORK IN THE DISMANTLING PHASE  
E' POSSIBILE MUOVERE META' CASSEFORMA DELLA COLONNA IN FASE DI DISARMO

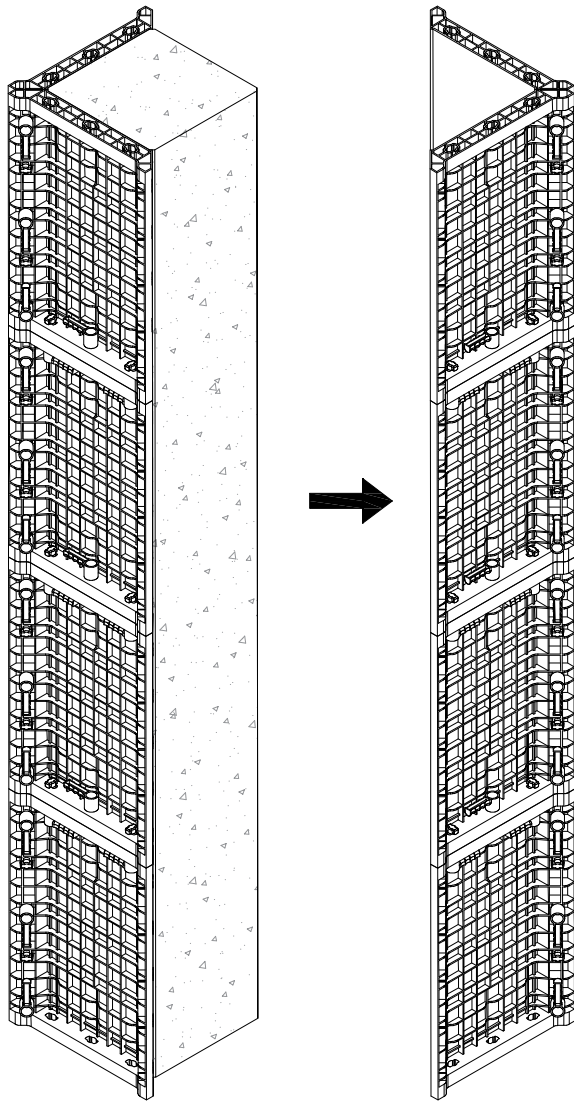

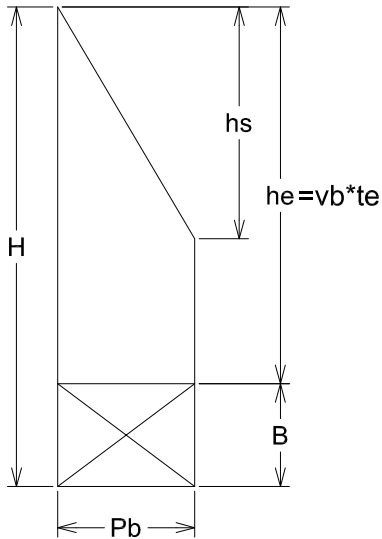

H = total height of the pour  
 hs = height of hydrostatic pressure,  
 i.e. maximum depth of fresh concrete pressure Pb  
 he = pour height  
 vb = pour speed  
 te = time (hours) from the time of mixing until pour completed  
 B = set concrete  
 Pb = maximum horizontal value of the fresh concrete pressure on formwork

H = altezza totale del getto  
 hs = altezza pressione idrostatica,  
 ossia profondità massima della pressione del calcestruzzo fresco Pb  
 he = altezza di getto  
 vb = velocità di getto  
 te = tempo (ore) dal momento della miscelazione fino al getto completato  
 B = calcestruzzo solidificato  
 Pb = massimo valore orizzontale della pressione del calcestruzzo fresco sul cassero

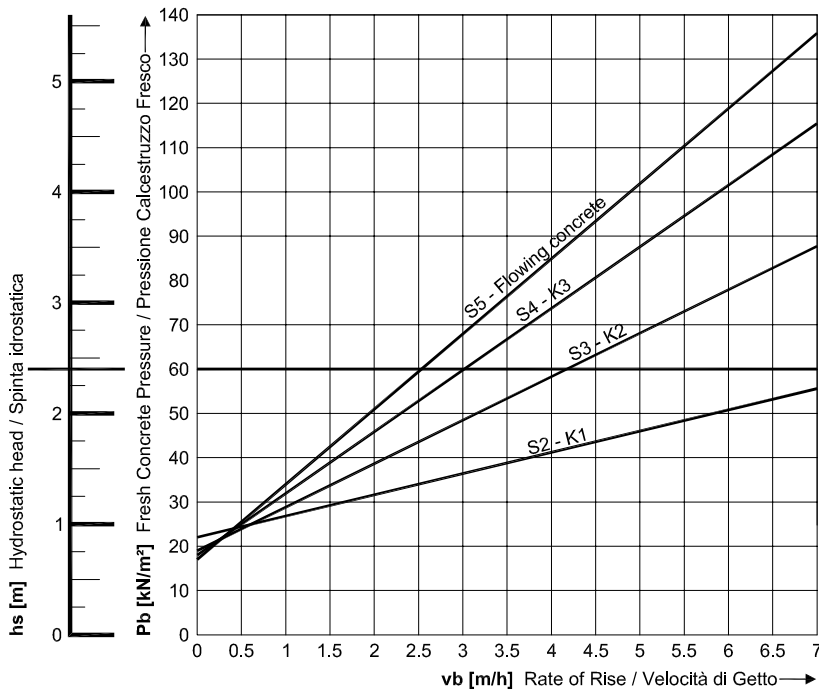

**MAXIMUM PERMISSIBLE PRESSURE OF FRESH CONCRETE: 60kN**

**Assumptions:**

- Specific weight of fresh concrete: 25 kN/m³
- Concrete set time: 5h
- Concrete temperature at placement: +15°C
- Concrete compacting with immersion vibrator

**SPINTA MASSIMA DEL CALCESTRUZZO FRESCO SOPPORTATA DEL CASSERO: 60kN**

**Assunzioni:**

- Peso specifico calcestruzzo compattato: 25 kN/m³
- Tempo di presa massimo: 5h
- Temperatura calcestruzzo al momento del getto: +15°C
- Compattazione con vibratori ad immersione

**GEOTUB PANEL: MAX POUR HEIGHT 3.00 m**

**GEOTUB PANEL: MASSIMA ALTEZZA DI GETTO 3.00 m**

**SAFETY NOTICE**

IN THE CASE OF POURS HIGHER THAN SHOWN IN THESE TABLES AND CHARTS PLEASE CONTACT THE TECHNICAL DEPT. OF GEOPLAST.

**AVVISO DI SICUREZZA**

PER ALTEZZE SUPERIORI A QUELLE RIPORTATE DALLE TABELLE, CONTATTARE L'UFFICIO TECNICO GEOPLAST.

CONSISTENCY CLASS	CLASSE DI CONSISTENZA	UNI EN 206:2006		DIN 18218	
		CLASSIFICAZIONE CLASSIFICATION	SLUMP	CLASSIFICAZIONE CLASSIFICATION	SPREADING
wet	umida	S1	10 ÷ 40 mm		
stiff	plastica	S2	50 ÷ 90 mm	F1 (K1)	≤ 34 cm
plastic	semifluida	S3	100 ÷ 150 mm	F2 (K2)	35 ÷ 41 cm
soft	fluida	S4	160 ÷ 210 mm	F3 (K3)	42 ÷ 48 cm
flowing	superfluida	S5	≥ 220 mm	F4 (flowing)	49 ÷ 55 cm

ABRAMS CONE  
CONO DI ABRAMS

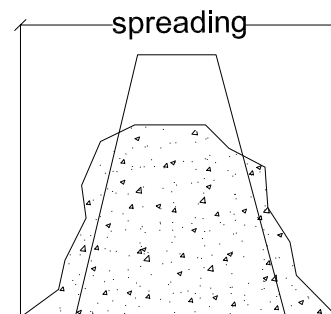
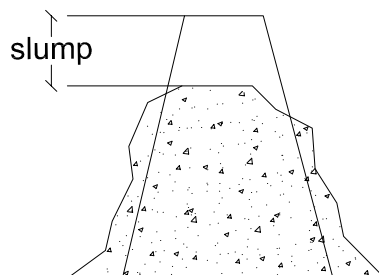

Use of retarding agent modify the concrete pressure through these coefficients.  
NOTE: according to UNI EN 206:2006 and UNI 11104:2004

Utilizzando agenti ritardanti la pressione del calcestruzzo deve essere modificata attraverso i seguenti coefficienti.  
NOTE: secondo normative UNI EN 206:2006 e UNI 11104:2004

CONSISTENCY CLASS	CLASSE DI CONSISTENZA	CLASSIFICATION / CLASSIFICAZIONE		SET TIME / TEMPO DI PRESA					
		UNI EN 206:2006	DIN 18218	5h	6h	7h	8h	9h	10h
stiff	plastica	S2	F1 (K1)	1.15	1.21	1.27	1.33	1.39	1.45
plastic	semifluida	S3	F2 (K2)	1.25	1.36	1.47	1.58	1.69	1.80
soft	fluida	S4	F3 (K3)	1.40	1.55	1.70	1.85	2.00	2.15

POUR

Only immersion type concrete vibrators are approved for use. The ABS formwork is not fireproof, do not place close to free flame or hot objects.

HANDLING

Use the lifting hook to transport the formwork with a crane. Before lifting make sure the load is symmetrical and that the leg lengths are equal.

CLEANING THE PANELS

After each use clean the panel with water, preferably using a pressure washer. Any residual concrete should be removed with the aid of a brush or a steel scraper.

RELEASING AGENT

As long as the contact surface of the panels does not show signs of wear, no releasing agent is required.

STORAGE

In order to facilitate the handling and lifting of the panels and all accessories, please store them on wood pallets or battens in order to keep them off the ground.

Although the product does not suffer weathering, for longer lifetime it is preferable to store the panels away from direct sunlight.

GETTO

Sono ammessi solamente sistemi di vibrazione ad immersione. Il cassero un ABS non è ignifugo, non porre a contatto diretto con corpi incandescenti o a fiamma libera.

MOVIMENTAZIONE

Utilizzare il gancio per Geopanel per sollevare i pannelli con gru e, prima della movimentazione, assicurarsi che le funi di sollevamento abbiano un uniforme tiraggio.

PULIZIA DEI PANNELLI

Al termine di ogni utilizzo, pulire i pannelli con getti di acqua (preferibilmente utilizzando una idropulitrice). Si consiglia di rimuovere eventuali incrostazioni del calcestruzzo con l'ausilio di una spatola o spazzola d'acciaio.

DISARMANTE

Finché la superficie di contatto dei pannelli non presenta segni di usura, non è necessario l'utilizzo di disarmanti.

STOCCAGGIO

Al fine di facilitare le operazioni di movimentazione e sollevamento dei pannelli e tutti gli accessori, stoccare gli stessi sopra bancali o comunque morali che permettano il distacco da terra.

Sebbene il prodotto non tema attacchi da agenti atmosferici è preferibile stoccare i pannelli in luoghi asciutti e riparati dalla luce diretta del sole.

The operations of placing, assembly, disassembly, plumb, handling and cleaning of the Geotub Panel product, as well as the pouring of the concrete must be carried out by qualified and properly trained personnel, or under the supervision of the Site Manager or an Engineer of Geoplast SpA, who must ensure that:

- all the above operations are carried out in a workmanlike manner,
- every person working with the formwork is equipped with suitable tools and personal protective equipment to perform all necessary actions in compliance with the safety standards,
- all panels and the supplied accessories are checked before use, and that any part that does not meet the minimum standards of reliability and safety due to deformation or breakage is discarded,
- the formwork is installed on a perfectly flat surface, so as to work in maximum safety conditions and guarantee perfect propping and plumb,
- all connection, alignment and plumb accessories of the formwork are tight and fixed to the ground before beginning the pour.

Geoplast SpA disclaims any liability arising from improper use of the formwork Geotub Panel. Any assembly of formwork and/or use of accessories otherwise described in this manual must first be approved by Geoplast SpA.

Le operazioni di posizionamento, montaggio, smontaggio, messa a piombo, movimentazione e pulizia del prodotto Geotub Panel, nonché del getto del calcestruzzo, devono essere effettuate da personale competente e debitamente istruito o comunque sotto il controllo del responsabile di cantiere oppure di un tecnico Geoplast SpA, i quali devono assicurarsi che:

- tutte le operazioni sopra elencate vengano svolte a regola d'arte,
- gli addetti alle operazioni sopra elencate siano muniti di idonea strumentazione e di dispositivi di protezione individuale per poter effettuare tutte le azioni nel pieno rispetto delle norme di sicurezza,
- tutti i pannelli e gli accessori in dotazione vengano controllati prima del loro utilizzo, in modo tale da poter eliminare quelli che non abbiano sufficiente garanzia di affidabilità a causa di eventuali presenze di rotture e/o deformazioni,
- il piano di appoggio dei casseri sia perfettamente piano, in modo da poter operare in massima sicurezza e garantire la perfetta puntellazione e piombatura dei pilastri,
- tutti gli accessori di collegamento, di allineamento e di piombatura dei casseri, siano ben serrati e fissati al suolo prima di iniziare le operazioni di getto.

Geoplast SpA declina ogni responsabilità derivante da un uso improprio dei casseri Geotub Panel. Eventuali assemblaggi dei casseri e/o uso di accessori diversamente illustrati in questo manuale, devono essere prima approvati da Geoplast SpA.





**GEOPLAST S.p.A.**

35010 Grantorto PD - Italia - Via Martiri della Libertà, 6/8  
tel +39 049 9490289 - fax +39 049 9494028  
e-mail: [geoplast@geoplast.it](mailto:geoplast@geoplast.it) - [www.geoplast.it](http://www.geoplast.it)

