

Technical data sheet NEW NAUTILUS EVO DOUBLE 41

1. DESCRIPTION

Recycled PP formwork for the construction of light bi-directional slabs with flat intrados and large spans.



2. TECHNICAL SPECIFICATIONS

Material	-	Recycled polypropylene (PP) 97-99%
	-	Additives 1-3%
Percentage of recycled material	%	100
Colour	-	Black
Dimensions *	cm	52x52x H13+28
Weight	kg	2.73 (± 10%)
Lower spacer height	cm	0-5-6-7-8-9-10
Upper spacer height	cm	0.8
Formwork volume *	m ³ /pz	0.081
Installation time (just plastic component)**	m ² /h/worker	30
Punching resistance	daN	190
Fire resistance***	-	REI 180
Place of production	-	Italy

* in consideration of the recycled material, the measures should be evaluated with a tolerance of ± 1,5%

** The laying times of the complete slab are subject to considerable variations depending on the amount of reinforcement and the working conditions of the workers.

***value referred to the UNI EN 1365-2 2002 and 1363 2012, carried out with standard sample with dimensions 2.98 x 7.33 m, thickness 28 cm and subjected to lasts sollicitation moment of at least REI 180' with a minimum reinforcement covering of 30mm (EOTA).

3. CONCRETE CONSUMPTION CHART

Lower spacer height p	Higher spacer height d	Beam T	Interax i	Incidence of formworks	Concrete consumption up to the formwork's satin	Formwork volume	Concrete saving up to the formwork's satin*
[cm]	[cm]	[cm]	[cm]	[pz/m ²]	[m ³ /m ²]	[m ³]	[m ³ /m ²]
0-5-6-7-8-9-10	0,8	12	64	2,44	0.215	0,081	0,195
0-5-6-7-8-9-10	0,8	14	66	2,30	0.225	0,081	0,185
0-5-6-7-8-9-10	0,8	16	68	2,16	0.235	0,081	0,175
0-5-6-7-8-9-10	0,8	18	70	2,16	0.247	0,081	0,163
0-5-6-7-8-9-10	0,8	20	72	1,93	0.255	0,081	0,155

* may also be taken into account the concrete saving due to the lower weight of the building

4. TECHNICAL DRAWINGS

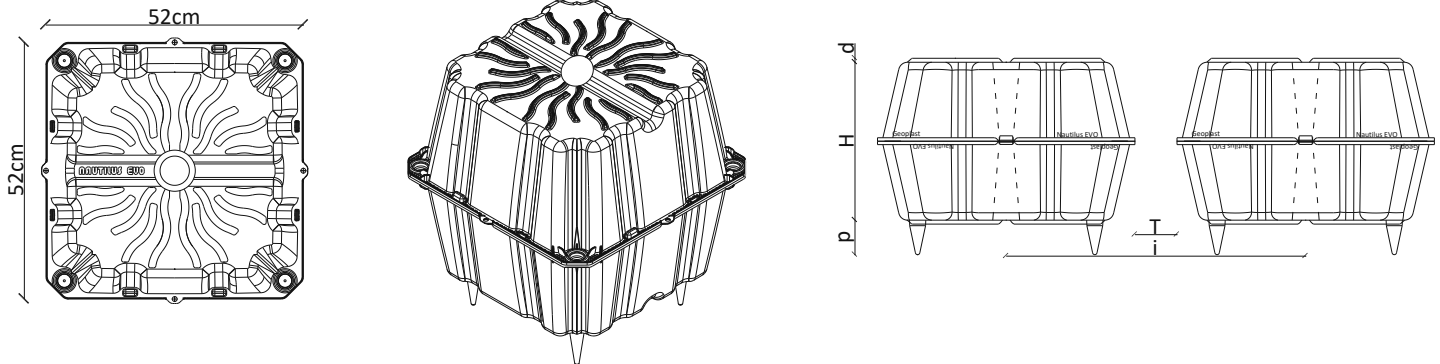

5. TECHNICAL SUPPORT

Geoplast Technical Unit is at the disposal of architects and engineers to offer the required assistance during the implementation of a project. From the statistical calculations to the working drawings.

- **FEASIBILITY STUDY:** Technical Analysis of the project which includes the choice of the most suitable product.
- **PRELIMINARY DESIGN:** Static analysis and preparation of documentation attesting to the reliability of the performance of the proposed system.
- **EXECUTIVE DESIGN AND ON-SITE ASSISTANCE:** Support of specialized designers. A detailed analysis with installation diagrams and/or on-site support can be provided on request.

6. PACKAGING AND TRANSPORT

Product code	-	ENNAEDH41XX
Code composition	-	1 pcs NEW NAUTILUS EVO DOUBLE with spacers included, 2 lateral spacers 10-20cm
Lower spacer height	cm	0-5-6-7-8-9-10
Packaging size	cm	110 x 120 x H250
Type of packaging	-	Stacked and wrapped in plastic film on pallet
Quantity per pallet	pz	215
Package gross weight *	kg	604

* weight may change by ($\pm 10\%$)