

# Technical data sheet NEW NAUTILUS EVO DOUBLE 52

## 1. DESCRIPTION

Recycled PP formwork for the construction of light bi-directional slabs with flat intrados and large spans.



## 2. TECHNICAL SPECIFICATIONS

Material	-	Recycled polypropylene (PP) 97-99%
	-	Additives 1-3%
Percentage of recycled material	%	100
Colour	-	Black
Dimensions *	cm	52x52x H24+28
Weight	kg	3.00 (± 10%)
Lower spacer height	cm	0-5-6-7-8-9-10
Upper spacer height	cm	0.8
Formwork volume	m <sup>3</sup> /pz	0.099
Installation time (just plastic component)**	m <sup>2</sup> /h/worker	30
Punching resistance	daN	190
Fire resistance***	-	REI 180
Place of production	-	Italy

\* in consideration of the recycled material, the measures should be evaluated with a tolerance of ± 1,5%

\*\* The laying times of the complete slab are subject to considerable variations depending on the amount of reinforcement and the working conditions of the workers.

\*\*\*value referred to the UNI EN 1365-2 2002 and 1363 2012, carried out with standard sample with dimensions 2.98 x 7.33 m, thickness 28 cm and subjected to lasts sollicitation moment of at least REI 180' with a minimum reinforcement covering of 30mm (EOTA).

## 3. CONCRETE CONSUMPTION CHART

Lower spacer height p	Higher spacer height d	Beam T	Interax i	Incidence of formworks	Concrete consumption up to the formwork's satin	Formwork volume	Concrete saving up to the formwork's satin*
[cm]	[cm]	[cm]	[cm]	[pz/m <sup>2</sup> ]	[m <sup>3</sup> /m <sup>2</sup> ]	[m <sup>3</sup> ]	[m <sup>3</sup> /m <sup>2</sup> ]
0-5-6-7-8-9-10	0,8	12	64	2,44	0.282	0,099	0,238
0-5-6-7-8-9-10	0,8	14	66	2,30	0.295	0,099	0,225
0-5-6-7-8-9-10	0,8	16	68	2,16	0.308	0,099	0,212
0-5-6-7-8-9-10	0,8	18	70	2,16	0.321	0,099	0,199
0-5-6-7-8-9-10	0,8	20	72	1,93	0.332	0,099	0,188

\* may also be taken into account the concrete saving due to the lower weight of the building

#### 4. TECHNICAL DRAWINGS

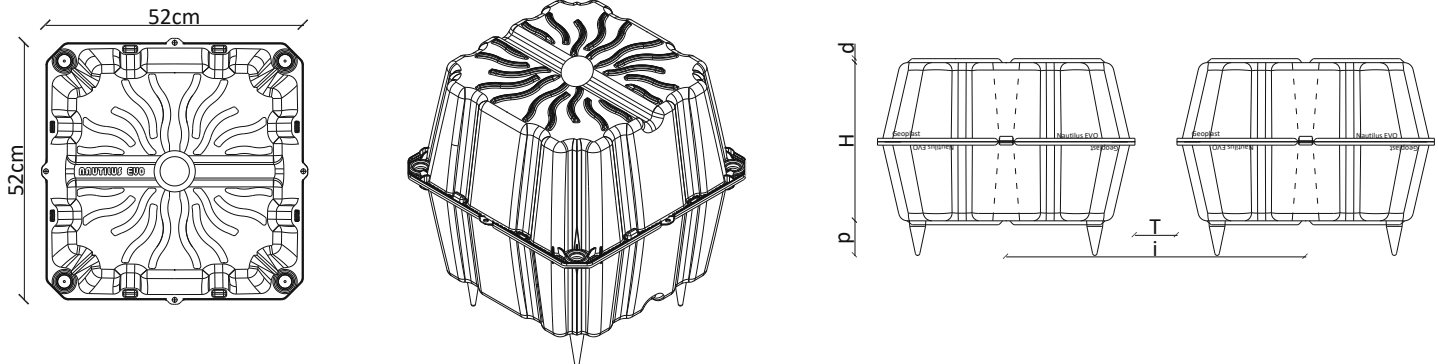

#### 5. TECHNICAL SUPPORT

Geoplast Technical Unit is at the disposal of architects and engineers to offer the required assistance during the implementation of a project. From the statistical calculations to the working drawings.

- **FEASIBILITY STUDY:** Technical Analysis of the project which includes the choice of the most suitable product.
- **PRELIMINARY DESIGN:** Static analysis and preparation of documentation attesting to the reliability of the performance of the proposed system.
- **EXECUTIVE DESIGN AND ON-SITE ASSISTANCE:** Support of specialized designers. A detailed analysis with installation diagrams and/or on-site support can be provided on request.

#### 6. PACKAGING AND TRANSPORT

Product code	-	ENNAEDH52XX
Code composition	-	1 pcs NEW NAUTILUS EVO DOUBLE with spacers included, 2 lateral spacers 10-20cm
Lower spacer height	cm	0-5-6-7-8-9-10
Packaging size	cm	110 x 120 x H250
Type of packaging	-	Stacked and wrapped in plastic film on pallet
Quantity per pallet	pz	200
Package gross weight *	kg	617

\* weight may change by ( $\pm 10\%$ )