

NEW ELEVATOR TECHNICAL MANUAL

PERMANENT CRAWL SPACE FORMWORK, UP TO 3 M

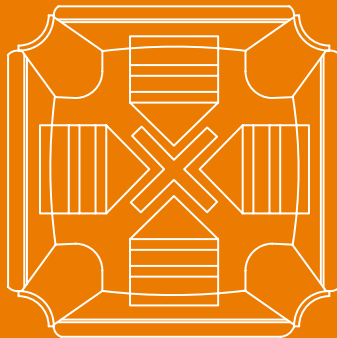

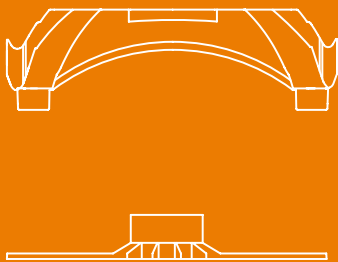

TECHNICAL DATA

1.INTRODUCTION

1.1 GENERALITIES

NEW ELEVETOR is a modular and single-use system made of 100% regenerated PP for crawl spaces up to 300 cm. The length of the PVC pipes varies according to the height of the crawl space as specified in the project. The formwork rests on PVC pipes with a diameter of 125 mm.

1.2 USE OF THE PRODUCT

NEW ELEVETOR system is ideal for the ventilation of reinforced concrete foundation slabs for residential, industrial and commercial buildings.

1.3 FUNCTIONALITY

The product consists of a formwork, PVC pipes and a patented grid which ensure a great load-bearing capacity. The system is modular and the formwork can be installed on-site in order to build a walkable and self supporting system which is ready for the concrete pour. When the concrete solidifies, it takes the form of NEW ELEVETOR, thus creating a supporting and completely ventilated crawl space.

1.3.1 STRUCTURAL CHARACTERISTICS

Depending on the expected project loads, the following elements may vary:

- Maximum height of the system;
- Reinforcement and thickness of concrete slab;
- Reinforcement of the pillars.

1.4 COMPONENTS

1.4.1 NEW ELEVETOR FORMWORK

The formwork has plan dimensions of 58x58 cm and a height of 15 cm. It is moulded in regenerated polypropylene (PP). It is equipped with a special coupling to facilitate a solid connection with the PVC pipe.



1.4.2 NEW ELEVETOR BASE

The base is a cross-shaped element with 4 arms of equal shape and size with a "glass" in the middle to receive the PVC tube. The base is 58x58 cm in size and 2.5 cm thick, with the glass 8 cm high; it is also made of regenerated polypropylene (PP). The functions of the base are as follows:

- Create a mesh on the bottom of the tank that speeds up the installation of the pipes, avoiding the need for preliminary tracing operations
- Keep the PVC pipes in a perfectly vertical position, in order to facilitate the installation of the formwork and maintain the stability of the system, which can be compromised in subsequent stages due to trampling or concrete pouring.



1.4.3 PIPES

The pipes are the typical orange PVC hoses for sewage connections with a diameter of $\Phi 125$ mm. They are cut to size according to the required height (in the factory or directly at jobsite) and become the feet of the formwork. For maximum simplicity and flexibility in the worksite NEW ELEVETOR uses only tubes of the indicated diameter.



1.4.4 LISTEL

It is an 8x10x100 cm polystyrene (PS) element that has a compensation function; it rests on the part of the pipe not covered by the formwork, to prevent the concrete from penetrating inside the under-floor cavity during the pouring of the slab.

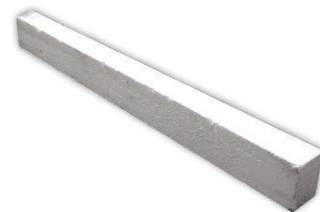

2. MATERIAL AND MANUFACTURING

2.1 MATERIAL

The formwork and base of NEW ELEVETOR are made of 100% regenerated polypropylene (PP). The material is chemically inert. It may suffer prolonged exposure to UV rays. Material properties are listed in the table.

CHARACTERISTIC	METHOD	U.D.M.	VALUE
MFI (190°C / 2,16 kg)	ASTM-D-1238	g/10'	5±1
Izod Resistance	ASTM-D-256	J/m	70-90
Flexible elastic modulus	ASTM-D-790	MPa	1.200-1.300
The softening temperature . vicat b/50n	ASTM-D-1525	°C	70-80
Density	ASTM-D-792	g/cm ³	0,89-0,92

The pipes are made of virgin PVC.
The material is chemically inert. It may suffer prolonged exposure to UV rays.
Material properties are listed in the table.

CHARACTERISTIC	METHOD	U.D.M.	VALUE
Resistance	DIN EN ISO 179	kJ/m ²	4
Yield strength	DIN EN ISO 527	MPa	58
Elastic modulus	DIN EN ISO 527	MPa	3.000
Melting point	-	°C	86-90
Density	ISO 1183	g/cm ³	1,40-1,42

Please refer to Appendix A for safety information on the use of materials.

2.2 MANUFACTURING PROCESS

NEW ELEVETOR formworks and bases are manufactured by injection moulding at the Geoplast plant in Grantorto (PD), Italy.

Geoplast Spa is a company with UNI EN ISO 9001:2000 quality certification.

Geoplast supplies extruded PVC pipes exclusively from certified suppliers.

3. TECHNICAL DATA

3.1 FORMWORK AND BASE NEW ELEVATOR

The technical characteristics of the formwork and base NEW ELEVATOR are shown in the table and dimensional drawings (Figure 1). The components are grey-black, with a smooth surface without engravings, air bubbles or inclusions.

		FORMWORK	BASE
Product code	-	EELEVEN5858	EELBASE5858
Dimensions	cm	58x58	58x58
Height	cm	15	2,5
Weight	kg	1,78	0,52

The formwork and base units can be easily interlocked with each other. Installation is from right to left and from top to bottom. The installation mode is marked on the lower left-hand side of the formwork. Marker arrows are also moulded on the formwork and bases to facilitate the correct installation. The elements must be installed taking care of the arrows and always pointing upwards. No fastening system required (screws, glues/silicones, clips).



The formwork and bases can be cut/shaped according to the design characteristics. The modifications shall be made as specified by Geoplast (see Appendix C) using an angle grinder or disc cutter.

3.2 PIPE

The characteristics of the PVC pipes to be used are shown in the table and dimensional drawings. The product is orange in colour, with a smooth surface without engravings, air bubbles or inclusions. The pipe is cut to size according to the design specifications.

	Product code*	-	EELTUBOXXX
Diameter	mm		125
Length	cm		75÷250
Material	-		PVC
Thickness	mm		1,8-2,0



*The code varies depending on the pipe length.

PVC pipes are supplied cut to size according to Geoplast's required height or in longer length to be cut at jobsite. If pipes from another supplier are used, they must necessarily have compatible characteristics with those given in this table.

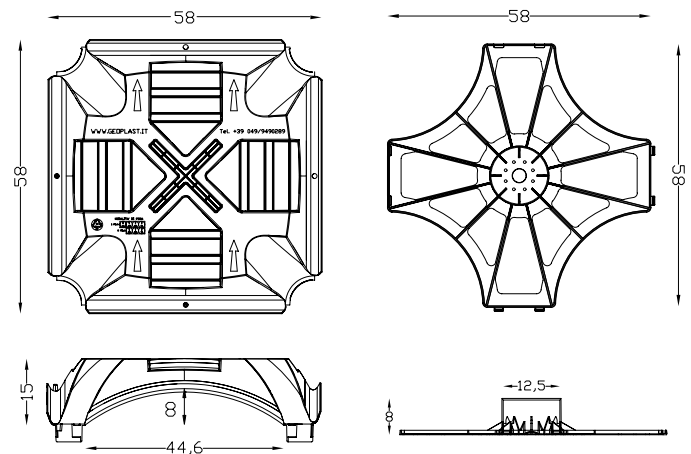

Fig. 1: Shaft and base of the dimensional drawings NEW ELEVATOR

3.3 LISTEL

The listel is a compensation element used for the closure of the space between the pipes and the formwork; it has the function of blocking the penetration of concrete into the under-floor cavity during the pouring phase. The length is equal to 1 m so that the support is always on at least 2 PVC pipes. It may be shortened as required.



Product code	-	EELLIST0100
Width	cm	8
Thickness	cm	10
Length	cm	100

3.4 CONCRETE CONSUMPTION

The consumption of concrete at the edge of the formwork must be calculated according to the following formula:

$$[0,037 \times (H \text{ system} - 0,15)] + 0,030 \text{ [m}^3/\text{m}^2]$$

With H system expressed in [m].

Example: Consumption of concrete in a 100 cm high system
 CLS consumption = $[0,037 \times (1 - 0,15)] + 0,030 = 0,061 \text{ m}^3/\text{m}^2$

3.5 SAFETY MEASURES

The installation of the product is completely manual, there is no mechanical handling. The installation can be carried out by the operator only because the weight of the components is less than the maximum liftable weight in optimal conditions (ISO 11228). When handling NEW ELEVATOR elements, attention should be paid to the following risks:

- It is possible to glide when walking over the formwork in wet weather conditions or in the presence of ice;
- Possible risk of falling if the system is not correctly installed or the operator does not pay due attention when walking over the structure;
- Risk of crushing during the mechanical handling of pallets;
- Risk of crushing during dismemberment operations;
- Risk of injury during the cutting of plastic parts.

For the installation of systems with a height of more than 150 cm, it is advisable to use stairs or raised platforms to install the formwork correctly. Do not place stairs or other structures directly on the plastic system.

During the installation phase of the formwork, if the construction site is unattended, it is essential to prevent access with appropriate physical barriers.



4. TRANSPORT AND STORING

The bases and the formwork of NEW ELEVATOR are stored and transported in pallets; the packaging characteristics are as follows:

	Dimensions (cm)	No. elements	surface m ²
FORMWORK	120x120xh265	225	75
BASE	110x110xh240	310	-

PVC pipes are also stored and transported in pallets, as well as polystyrene strips. Pallet sizes vary depending on the length and number of pieces.

For the loading and unloading of the pallets it is possible to use mechanical means like cranes or equipped lifting straps. For a correct storage it is recommended to choose a stable and as regular surface as possible; the product must remain protected from contact with fuels, lubricants, chemicals or acids.

Exposure to UV radiation should be as limited as possible.

The following operations must be avoided once the elements are removed from the pallet:

- Improper storage of components (overlapping pallets, bulk stacking of components,...);
- Inadequate handling (steering, dragging,...);
- Contact or impact with sharp or blunt bodies (stones, blades,...).

IMPORTANT: Before installation, it must be verified that the elements are intact (the characteristics described in paragraphs 3.1 and 3.2 must be observed). Avoid installation if there is any damage or defects in the formwork, grids or PVC pipes.

5. LOADS

The maximum height of the system is 3,00 m or less, infueced to the maximum permissible loads that the structure will be withstand.

The contribution of the plastic structure of NEW ELEVATOR in terms of load resistance can be considered (on a simplified level) negligible. Therefore, during the structural calculation it needs to be considered only the contribution of the reinforced concrete.

Depending on the applied loads, they must be defined:

- Thickness and type of reinforcement of the upper floor sub- structure;
- Type of reinforcement irons that need to be inserted in the pillar;
- Thickness of the foundation base on which the formwork system is installed.

6.1 INSTALLATION

The installation sequency is the following:

- Shaping and installation of the basis;
- Laying of PVC pipes;
- Shaping and installation of the formworks;
- Insertion of polystyrene listels to compensate the spaces between beam/crawl spaces.

The installation of the formworks and of the base grids must proceed from right to left and from top to bottom. Once installed, the system is walkable.

It is walkable during the installation stage, only if 5 rows of formworks are in full support of at least 3 perimeter walls which can support the tank. The complete installation instructions are described in Appendix C.

6.2 SYSTEM'S REINFORCEMENTS

The welded wire mesh must be laid above the formwork, possibly with spacers to be placed between the iron and plastic to ensure that the mesh is in the middle of the slab.

The reinforcements have to be inserted into the pillars.

They must be long enough to cover the entire length of the PVC pipe, touching the support bases, and can be hooked to the upper mesh. The reinforcements are shaped according to the specifications provided:

- “Umbrella-shaped” in case 1 reinforcement per pillar is sufficient;
- “U-shaped” in case 2 or 4 should be inserted.

Attention should be paid during this stage when walking above the formwork, especially where the welded mesh has already been positioned.

6.3 POUR

We recommend the use of concrete with minimum strength class C25/30 and consistency class S4.

The procedure involves the filling of the PVC pipes first, until the edge of the formwork and then with pouring of the slab.

It is advisable to pour at close distance, keeping the pump entrance at 20-30 cm of distance from the formworks. Immersion vibrators must not be used inside the PVC pipes.



APPENDIXES

APPENDIX A

MATERIAL SAFETY DATA SHEET

A1 – NEW ELEVATOR FORMWORK AND BASE

COMPOSITION / POLYMER INFORMATION

INGREDIENTS	N° C.A.S.	%
Polyethylene Random	9010-79-1	97-99
Additives	Not available	1-3

DANGEROUS COMPONENTS

This product does not fall within the definition of hazardous material provided by EEC 1999/45 and subsequent regulatory measures.

Physical state: Solid.

Problems: If the polymer is subjected to high temperatures it can produce vapours irritating to the respiratory system and eyes.

FIRST AID MEASURES

Inhalation of decomposition products: Keep patient calm, move patient to fresh air and call for medical help.

Skin contact: parts that come into contact with molten material must be quickly brought under running water and the doctor must be contacted.

Eye contact: flush eyes for at least 15 minutes under running water while holding eyelids open. Contact with material particles does not present any particular danger, except for the possibility of abrasion wounds. Fine particles can cause irritation.

Ingestion: No particular measures to be taken.

FIRE-FIGHTING MEASURES

Extinguishing materials: water, foam or dry extinguishing materials.

Unsuitable extinguishing materials: none.

Substances released in the event of fire: carbon dioxide (CO₂) and mainly steam. Other substances that may form: carbon monoxide (CO), monomers, other degradation products.

Special protective equipment: Wear breathing apparatus in case of fire.

Other requirements: Dispose of contaminated combustion slag and fire extinguishing material in accordance with local regulations.

ACCIDENTAL RELEASE MEASURES

It is not classified as a hazardous material. It can be recycled, incinerated or disposed of in landfills in accordance with local regulations.

STORAGE AND HANDLING

When the product is ground, the applicable dust regulations must be taken into account.

Keep it in a dry place.

EXPOSURE CONTROL/PERSONAL PROTECTION

Respiratory tract protection: if respirable dust forms, P1 filters (DIN 3181) must be used.

Skin protection: no special precautions.

Eye protection: safety glasses in the presence of free particles.

PHYSICO-CHEMICAL PROPERTIES

Shape	Panels
Color	Dark grey-black
Smell	Soft
Change in physical state	Melting temperature: above 140°C Combustion temperature: above 400°C
Flammability	Flammable, not easily ignited
Density	0.91-0.97 kg/dm ³
Solubility in water	Insoluble
Solubility in other solvents	Soluble in aromatic solvents

STABILITY AND REACTIVITY

Conditions to avoid	Do not overheat to prevent thermal decomposition. The process begins at around 300°C
Thermal degradation products	Monomers and other sub-products

TOXICOLOGICAL INFORMATION

Acute toxicity: data not available (no animal experiments due to impossibility related to product conformation). Insoluble in water.



ECOLOGICAL INFORMATION

Degradation in nature: no data available.

Insoluble in water.

Behaviour and environmental purpose: the product is environmentally friendly because it is made of recycled plastic. It is not apparently biodegradable due to its water insolubility and consistency.

DISPOSAL CONSIDERATIONS

Product 100% recyclable. It can be disposed of in landfills or incinerated, in accordance with local regulations.

TRANSPORT INFORMATION

It is not classified as dangerous for transport purposes.

REGULATORY INFORMATION

It is not subject to the CE marking.

A2 – PIPES

COMPOSITION / POLYMER INFORMATION

INGREDIENTS	N° C.A.S.	%
Polyvinyl chloride	9002-86-2	about 75
Calcium carbonate	1317-65-3	about 25
Other (waxes-stabilizers)	Not available	1-2
Pigments	Not available	2

DANGEROUS COMPONENTS

This product does not fall within the definition of hazardous material provided by EEC 1999/45 and subsequent regulatory measures.

Physical state: Solid.

Problems: If the polymer is subjected to high temperatures it can produce vapours irritating to the respiratory system and eyes.

FIRST AID MEASURES

Inhalation of combustion products: Keep the patient calm, move him/her to fresh air and call for medical help.

Contact of molten material with skin: parts that come into contact with molten material must be quickly brought under running water and the doctor must be contacted.

Contact of dust or material particles with eyes: wash eyes for at least 15 minutes under running water while holding eyelids open. Contact with material particles does not present any particular danger, except for the possibility of abrasion wounds. Fine particles can cause irritation.

Ingestion: No particular measures to be taken.

FIRE-FIGHTING MEASURES

Extinguishing materials: water, foam or dry extinguishing materials.

Unsuitable extinguishing materials: none.

Substances released in the event of fire: carbon dioxide (CO₂) and mainly steam. Other substances that may form: carbon monoxide (CO), monomers, other degradation products.

Special protective equipment: Wear breathing apparatus in case of fire.

Other requirements: Dispose of contaminated combustion slag and fire extinguishing material in accordance with local regulations.

ACCIDENTAL RELEASE MEASURES

It is not classified as a hazardous material. It can be recycled, incinerated or disposed of in landfills in accordance with local regulations.

STORAGE AND HANDLING

When the product is ground, the applicable dust regulations must be taken into account.

Keep it in a dry place.

EXPOSURE CONTROL/ PERSONAL PROTECTION

Respiratory tract protection: if respirable dust forms, P1 filters (DIN 3181) must be used.

Skin protection: no special precautions.

Eye protection: safety glasses in the presence of free particles.

PHYSICO-CHEMICAL PROPERTIES

Shape	Tubular
Color	Grey or orange
Smell	Soft
Change in physical state	Melting temperature: above 75°C Combustion temperature: above 400°C
Flammability	Flammable, not easily ignited
Density	1,7 kg/dm ³
Solubility in water	Insoluble
Solubility in other solvents	Soluble in aromatic solvents

STABILITY AND REACTIVITY

Conditions to avoid	Do not overheat to prevent thermal decomposition. The process begins at around 300°C
Thermal degradation products	Monomers and other sub-products

TOXICOLOGICAL INFORMATION

Acute toxicity: data not available (no animal experiments due to impossibility related to product conformation).

Insoluble in water.



ECOLOGICAL INFORMATION

Degradation in nature: no data available.

Insoluble in water.

Behaviour and environmental purpose: the product is environmentally friendly because it is made of recycled plastic. It is not apparently biodegradable due to its water insolubility and consistency.

DISPOSAL CONSIDERATIONS

Product 100% recyclable. It can be disposed of in landfills or incinerated, in accordance with local regulations.

TRANSPORT INFORMATION

It is not classified as dangerous for transport purposes.

REGULATORY INFORMATION

It is not subject to the CE marking.

A3 – LISTEL

COMPOSITION / POLYMER INFORMATION

INGREDIENTS	N° C.A.S.	%
Polystyrene	9003-53-6	97-99
Additives	Not available	1-3

DANGEROUS COMPONENTS

This product does not fall within the definition of hazardous material provided by EEC 1999/45 and subsequent regulatory measures.

Physical state: Solid.

Problems: If the polymer is subjected to high temperatures it can produce vapours irritating to the respiratory system and eyes.

FIRST AID MEASURES

Inhalation of combustion products: Keep the patient calm, move him/her to fresh air and call for medical help.

Contact of molten material with skin: parts that come into contact with molten material must be quickly brought under running water and the doctor must be contacted.

Contact of dust or material particles with eyes: wash eyes for at least 15 minutes under running water while holding eyelids open. Contact with material particles does not present any particular danger, except for the possibility of abrasion wounds. Fine particles can cause irritation.

Ingestion: No particular measures to be taken.

FIRE-FIGHTING MEASURES

Extinguishing materials: water, foam or dry extinguishing materials.

Unsuitable extinguishing materials: none.

Substances released in the event of fire: carbon dioxide (CO₂) and mainly steam. Other substances that may form: carbon monoxide (CO), monomers, other degradation products.

Special protective equipment: Wear breathing apparatus in case of fire.

Other requirements: Dispose of contaminated combustion slag and fire extinguishing material in accordance with local regulations.

ACCIDENTAL RELEASE MEASURES

It is not classified as a hazardous material. It can be recycled, incinerated or disposed of in landfills in accordance with local regulations.

STORAGE AND HANDLING

When the product is ground, the applicable dust regulations must be taken into account.

Keep it in a dry place.

EXPOSURE CONTROL/PERSONAL PROTECTION

Respiratory tract protection: if respirable dust forms, P1 filters (DIN 3181) must be used.

Skin protection: no special precautions.

Eye protection: safety glasses in the presence of free particles.

PHYSICO-CHEMICAL PROPERTIES

Shape	Panels, profiled
Color	White-grey
Smell	Soft
Change in physical state	Melting temperature: above 100-140°C Combustion temperature: above 450°C
Flammability	Flammable, not easily ignited
Density	1,04 kg/dm ³
Solubility in water	Insoluble
Solubility in other solvents	Soluble in aromatic solvents

STABILITY AND REACTIVITY

Conditions to avoid	Do not overheat to prevent thermal decomposition. The process begins at around 270°C
Thermal degradation products	Monomers and other sub-products

TOXICOLOGICAL INFORMATION

Acute toxicity: data not available (no animal experiments due to impossibility related to product conformation).

Insoluble in water.



ECOLOGICAL INFORMATION

Degradation in nature: no data available.

Insoluble in water.

Behaviour and environmental purpose: the product is environmentally friendly because it is made of recycled plastic. It is not apparently biodegradable due to its water insolubility and consistency.

DISPOSAL CONSIDERATIONS

Product 100% recyclable. It can be disposed of in landfills or incinerated, in accordance with local regulations.

TRANSPORT INFORMATION

It is not classified as dangerous for transport purposes.

REGULATORY INFORMATION

It is not subject to the CE marking.

APPENDIX B

DIMENSIONING INDICATIONS

BENDING CHECK

The flexing test of the upper slab is carried out by taking as reference a strip of slab equal to the diagonal distance between two pillars, therefore, since the system is made up of cylindrical elements placed at a distance of 58 cm, the width of the strip to be taken into consideration will be equal to $58\sqrt{2}$ or 82 cm.

This strip is calculated as a continuous beam on multiple supports identifiable with pillars, the situation that occurs is identified in the following scheme where you look for the combination of load that maximizes the moment in span:



PUNCHING VERIFICATION

The punching test of the upper slab is carried out by requiring that:

$$v_{sd} = \frac{V_{sd}}{u} < V_{Rd1} = \tau_{rd} \cdot k \cdot (1.2 + 40\rho)d$$

Where::

V_{sd} is the driving force.

u represents the critical perimeter variable according to the characteristic load footprint of the acting concentrated action:

$$v_{sd} = \frac{V_{sd}}{u}$$

τ_{rd} represents the tangential tension depending on the class of concrete d represents the useful height of the section and K is the correcting parameter related to it:

$$K = 1.6 - d$$

ρ represents the percentage of reinforcement, therefore the residual cut is obtained and compared to the stressing action.

PILLARS VERIFICATION

The verification calculation of the pillars is carried out with reference to the press-flex verification and the calculation is carried out with reference to an isolated pillar, this simplification is also to the benefit of safety, because it does not consider the advantageous effect that close pillars operate.

The process begins with checking the leanness ratio λ whose value must be less than 50 in order not to have problems of instability.

The instability depends on the free length of inflection l_0 influenced by the type of constraint to which the element is subjected, which in the case of the NEW ELEVATOR system is represented by interlocking in the upper part and hinge in the lower part, and by the radius of inertia of the section, therefore:

$$\lambda = \frac{l_0}{i_m}$$

The calculation of the pile must lead to the verification that the voltage acting is lower than the permissible concrete tension, i. e.:

$$\sigma_{max} = -\frac{P_{tot}}{A_c + nA_a} - \frac{M}{W} < \bar{\sigma}_{amm}$$

Where:

P_{tot} represents the total load acting on the pillar.

$A_c + nA_a$ is the ideal section area:

$$A_c + nA_a = \pi \cdot r^2 + 15 \cdot (1 \cdot \varnothing 6) = \pi \cdot 6.25^2 + 15 \cdot (1 \cdot 0.28) = 127 \text{ cm}^2$$

M is the stimulating moment acting on the section composed of two factors:

M1: Assuming that the load (P_{tot}) is applied with respect to the barycentre of the section with an eccentricity of 2cm, i. e. internal to one third of the section.

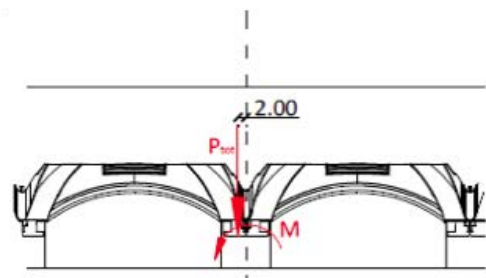

M2: represents the moment due to a braking action of a possible vehicle; supposing that the braking action is equal to 1/10 of the vertical action, and given the geometry of the loading system it is plausible to assume that the load dissipates along the thickness of the pavement until it becomes almost zero in correspondence of the foot, so it is assumed to take an aliquot of 5% of the load to be applied as a stressing moment, therefore it appears that the braking force is equal to:

$$F = (P / 10) \times 0.05 = 0.275 \text{ kN}$$

The arm of this force is equal to the distance between the upper surface application line of the slab and the reinforcement line, i. e. d, so moment M2 is equal to:

$$M2 = F \times d$$

Therefore:

$$M = M1 + M2$$

W represents the resistance module of the cross section, which for a circular section is equal to:

$$W = \frac{\pi \cdot D^3}{32}$$

GROUND PRESSURE CHECK

Each pillar unloads a pressure on the ground on an area identified by the area of the pillar itself, the pressure calculation, which must be compared with the structural system on which the system rests, takes place in the following way:

$$\sigma_{ter} = \frac{N}{A_p}$$

Where:

N represents the total agent force at the base of the pillar equal to :

$$N = P_{tot} + P_p$$

A_p represents the foot area:

$$A_p = \pi r^2 = \pi 6,25^2 = 122,7 \text{ cm}^2$$

The contact pressure thus determined must be supported by a suitably rated and dimensioned base.

APPENDIX C

INSTRUCTIONS FOR USE NEW ELEVATOR

SAFETY INSTRUCTION



INSTRUCTIONS OF USE: workers are recommended to work with diligence and carry on the works correctly. Even though it is not mentioned in this document, regulations in law (such as: Technical standards, Guidelines and regulations,...) must be observed.

1. SAFETY: All operations must be carried out while wearing personal protection equipment (PPE) and in accordance with the instructions provided by your SOP.

It is good safety practice to walk on the domes only after laying the mesh.

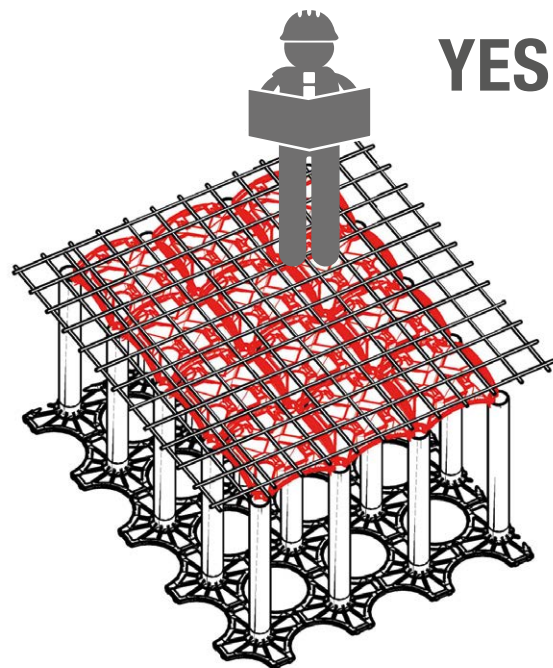
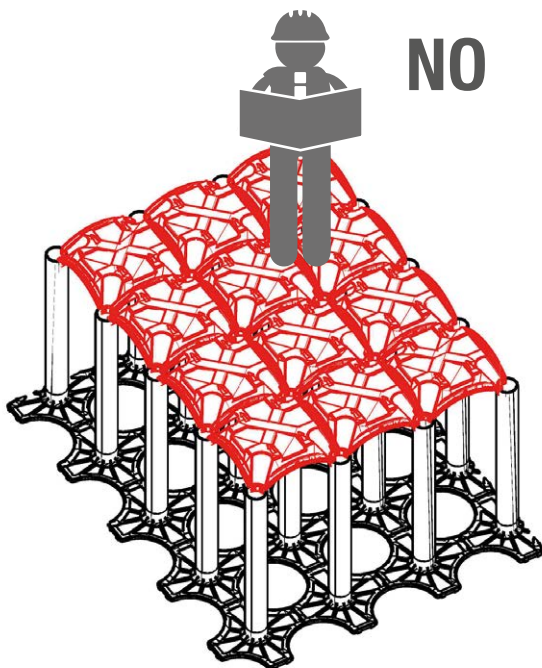

INSTALLATION MODE

Before proceeding with the installation of the New Elevator system, the following aspects must be checked:

- The walls and bottom of the tank must have been completely constructed, including any internal partitions.
- The bottom must be perfectly flat, smooth, free of obstacles and with the slope planned by the project.
- The side walls and internal partitions must be perfectly vertical.
- The supplying/discharge pipes must already be prepared.

It is advisable to consult carefully the graphical drawing of the project plan provided by Geoplast's technical office, indicating the starting point of the installation and the direction.

OPERATION N°1: cut the bases as shown in the diagram and place the first row on the wall. Lay from left to right and from top to bottom.

On the sides of the bases there are 2 indicator arrows for correct installation. Make sure that they are always facing upwards.

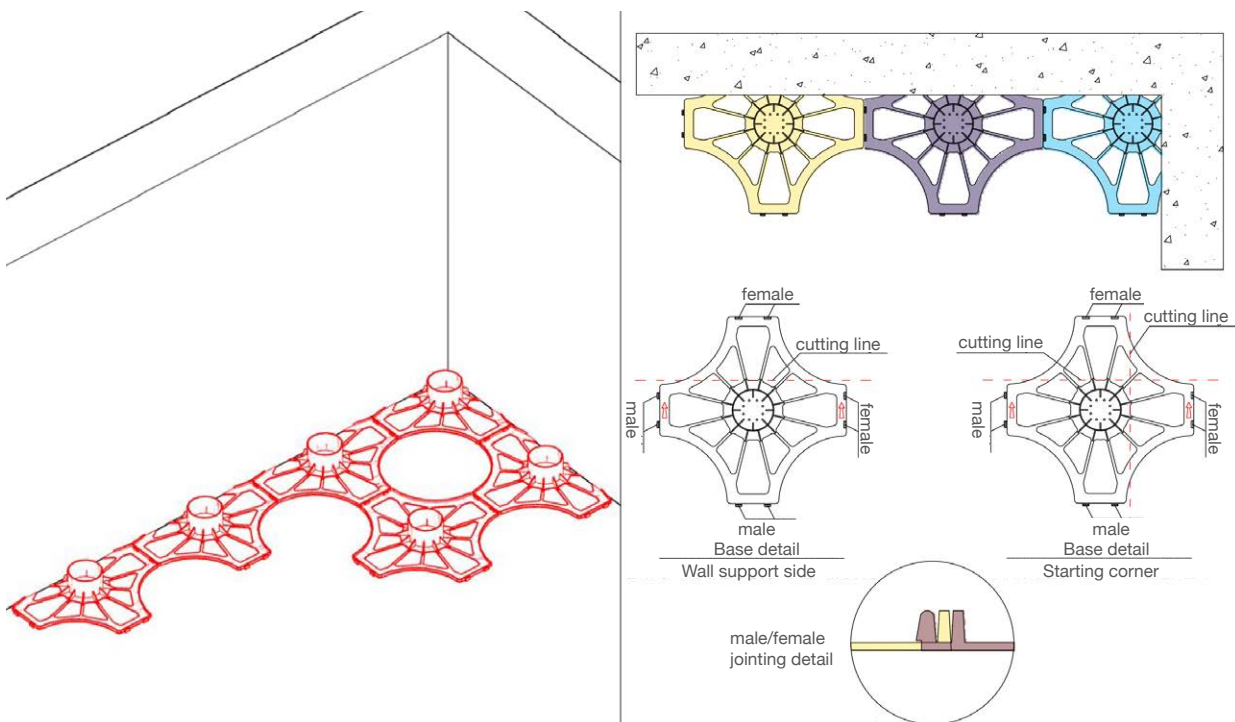

OPERATION N°2: position the pvc pipes in the bases exerting an adequate pressure to ensure correct interlocking. Make sure that the tube is fully positioned at the bottom of the base.

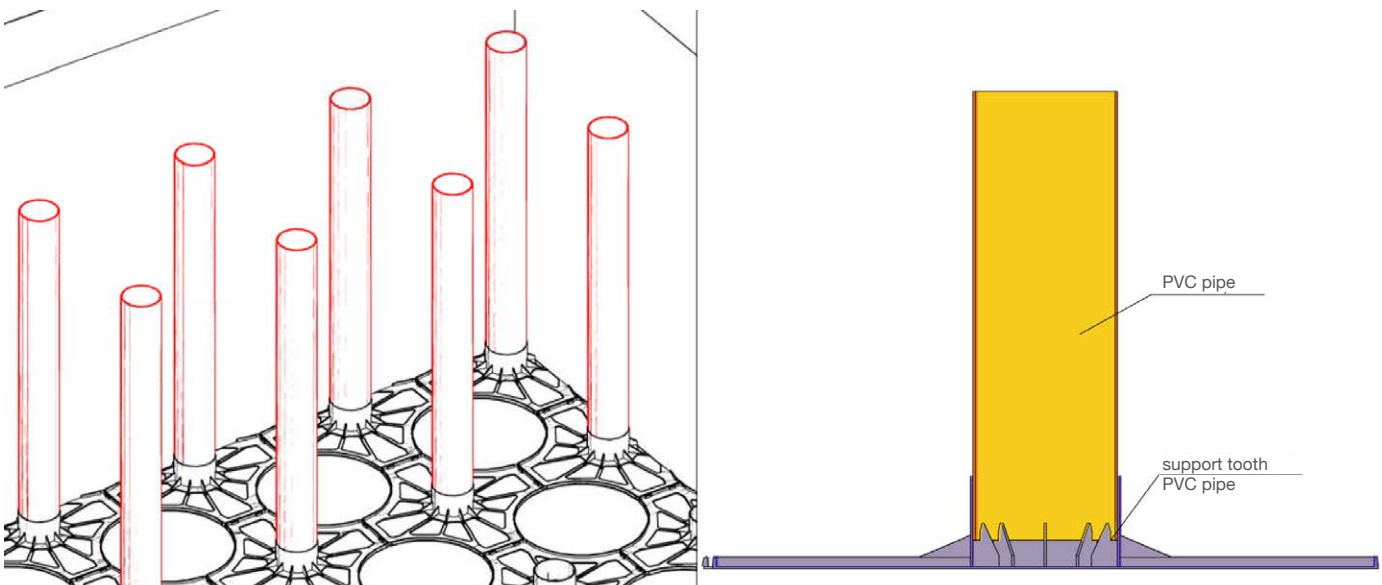

OPERATION N°3: install the NEW ELEVATOR, taking care to ensure that it fits perfectly into the pipes. Lay the formwork from left to right and from top to bottom. Be careful to place the formwork with the arrows on top of it facing upwards. Observe the instructions in the installation diagram supplied by Geoplast's technical department.

The system becomes dry walkable when at least 5 rows of formworks have been laid and these rows are placed on at least 3 sides of the tank. For the installation of systems higher than h=150 cm it is possible to use stairs or raised structures, provided they do not rest directly on the plastic system.

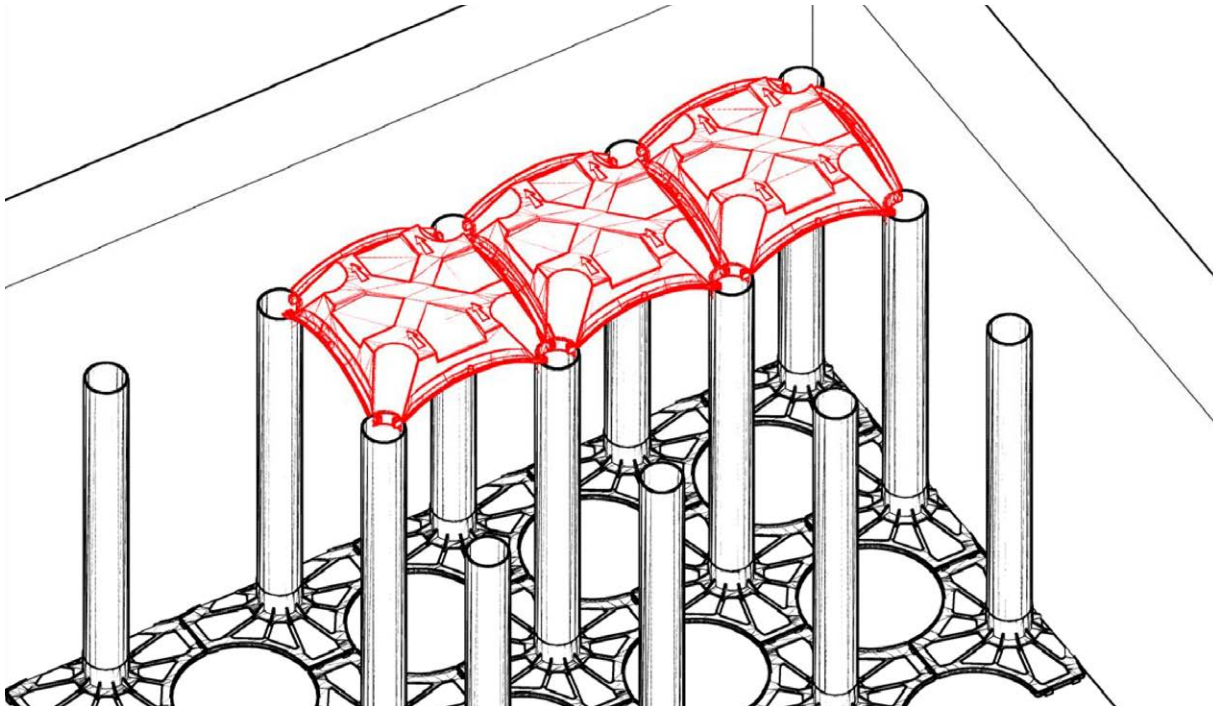

position the domes by placing them from right to left

Initial position of New Elevator dome laying

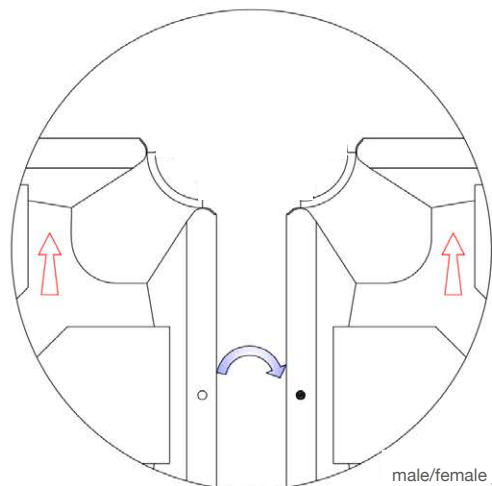
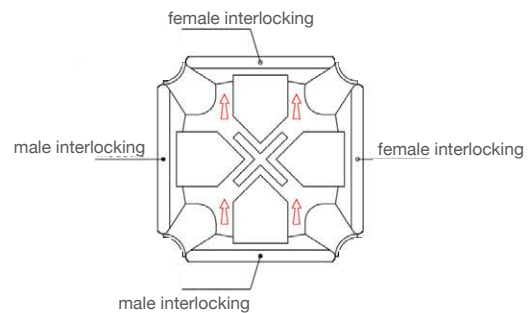
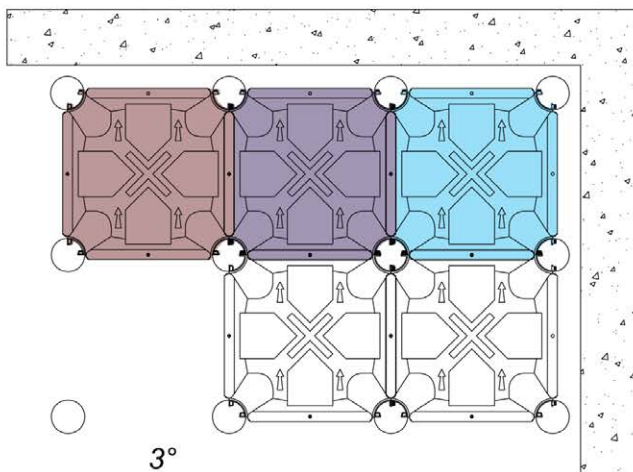

male/female jointing detail

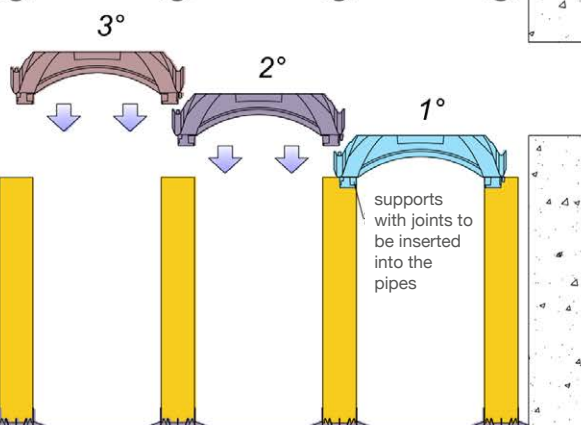

OPERATION N° 3.1 - INSTALLATION OF FORMWORK CLOSE TO THE PERIMETER WALLS.

CASE 1: full dome behind the wall. In this case it is necessary to create a support for the formwork by fixing a wooden listel to the wall.

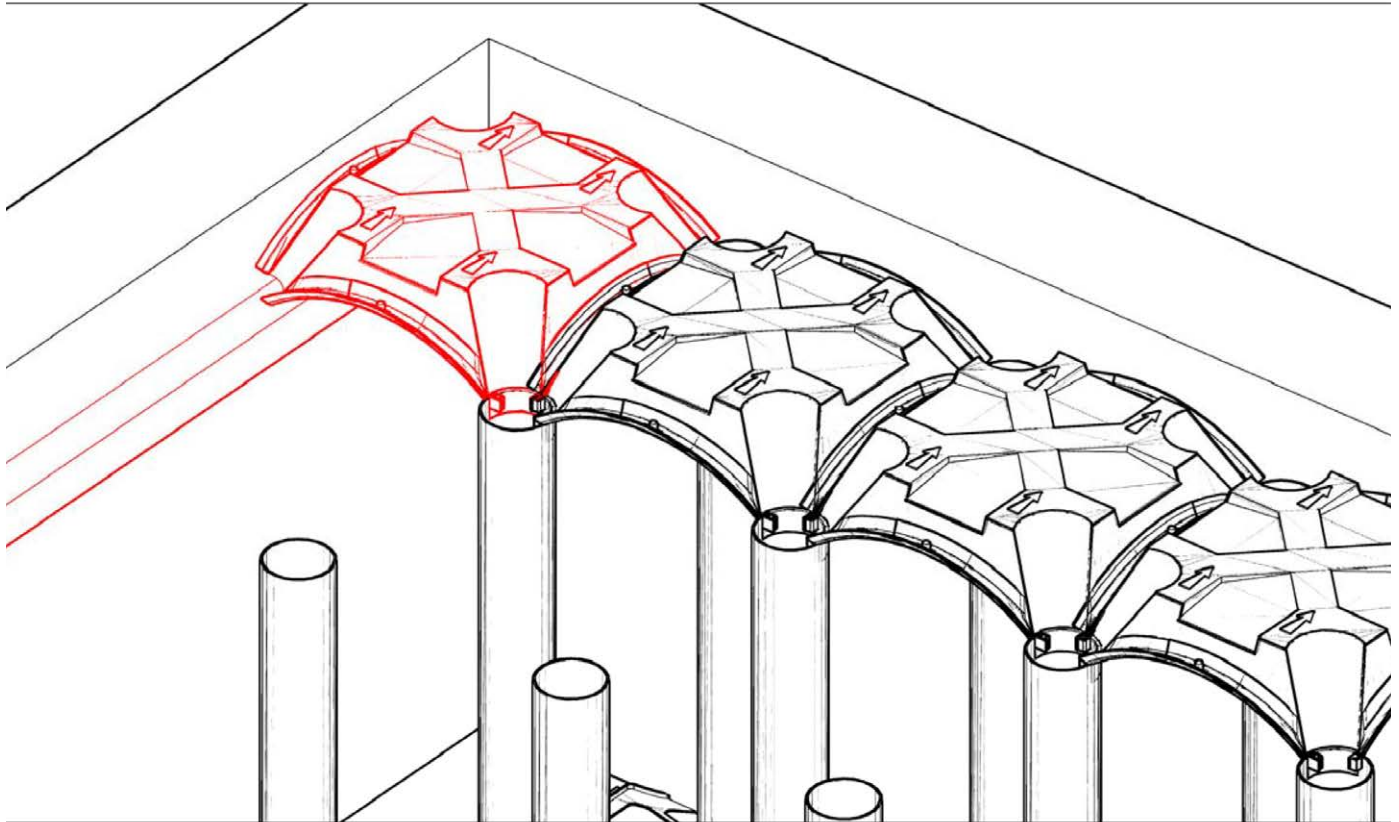

Fix the wooden batten to the same height as the dome to the pipe using pressure dowels.

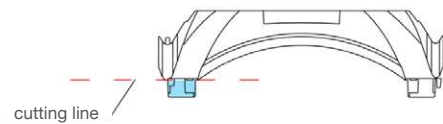
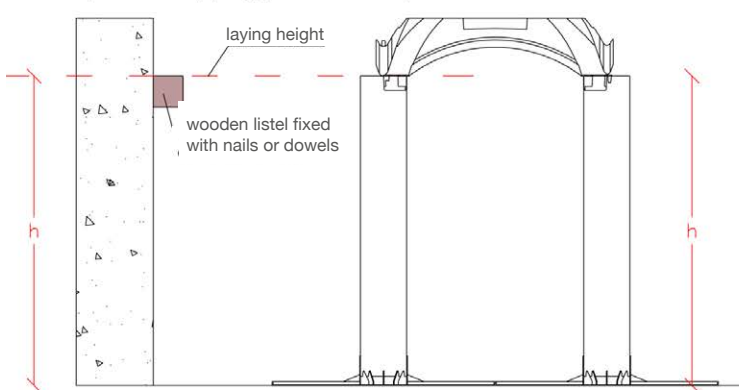

Cut the pipe fastening inserts and place the dome on the wooden listel.

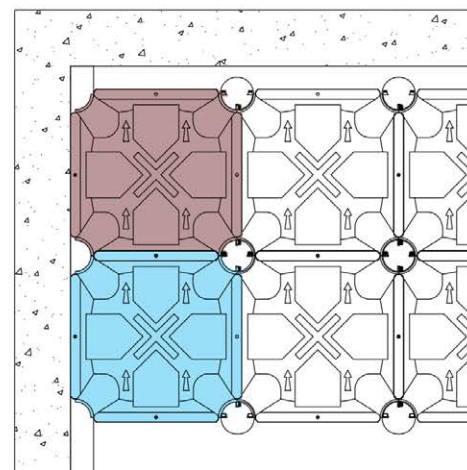
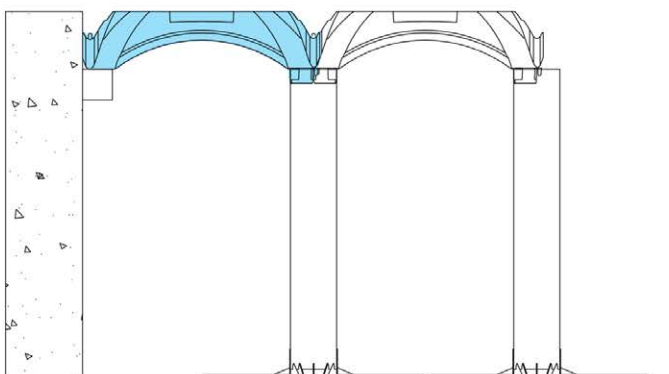

CASE 2: dome cut close to the wall. The formwork can be shaped with a flexible hose. Before cutting, accurately measure the space available for the formwork.

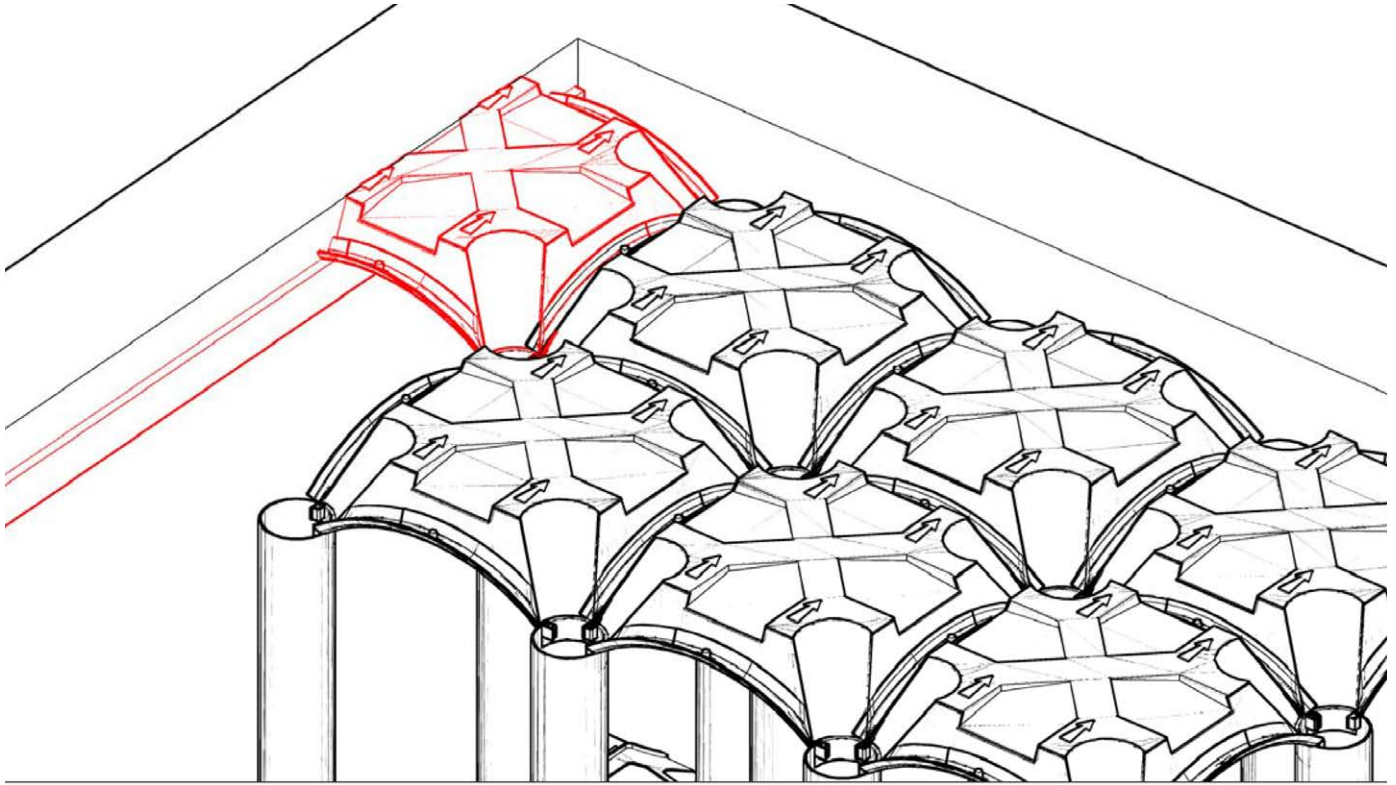

Fix the wooden listel to the same height as the dome cut.

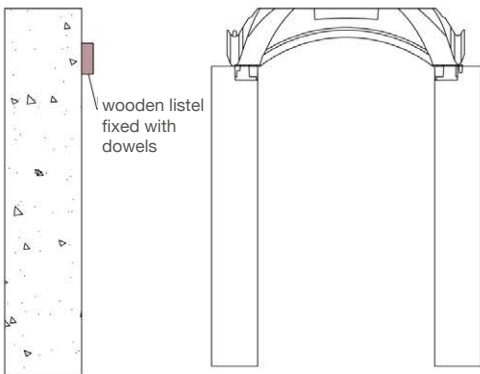

Cut the dome and place it on the wooden listel.

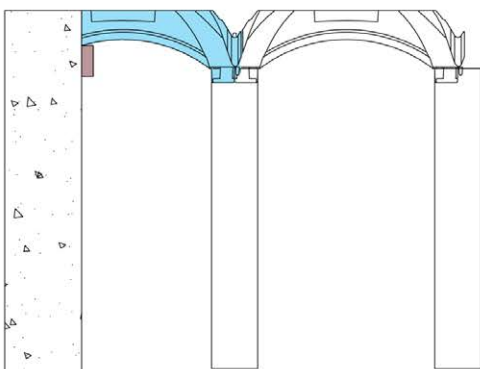

wooden listel fixed with dowels

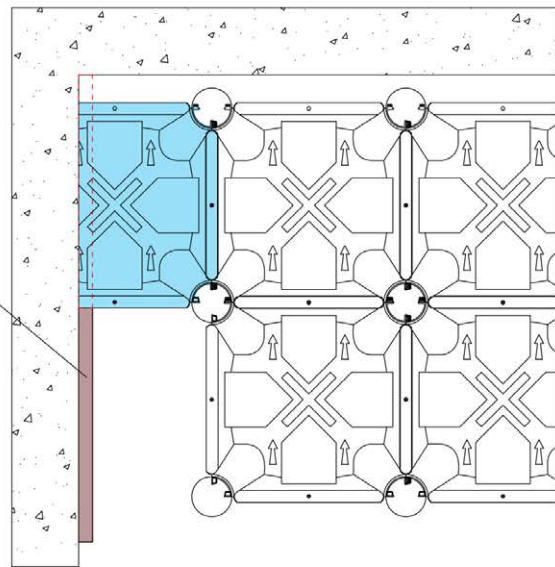

CASE 3: in this case, it is not necessary to create a support, but polystyrene listels (supplied by Geoplast) must be laid between the formwork and the wall. It must be ensured that each listel has at least 2 supports on the PVC pipes. It is not necessary to fix the listels to the wall.

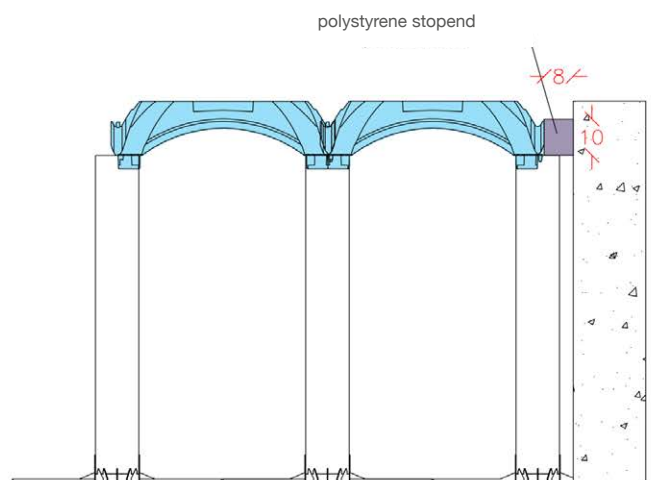
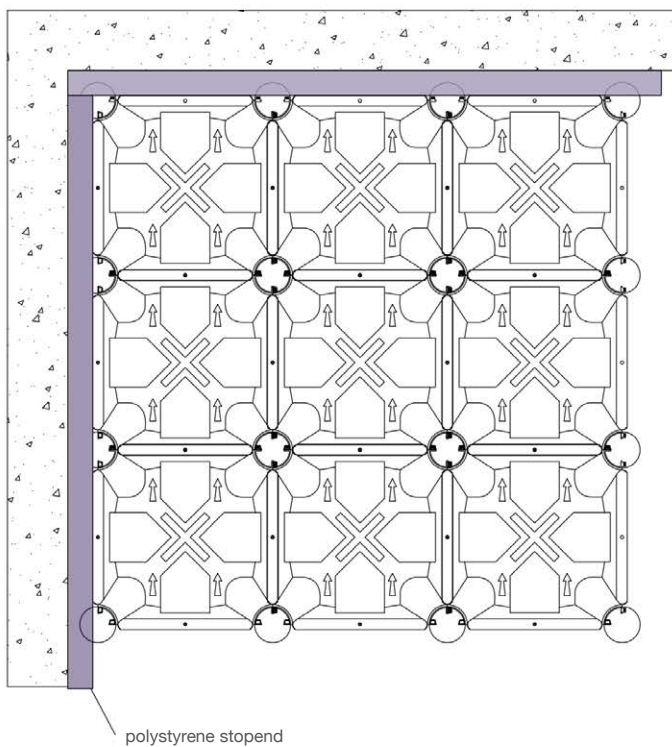
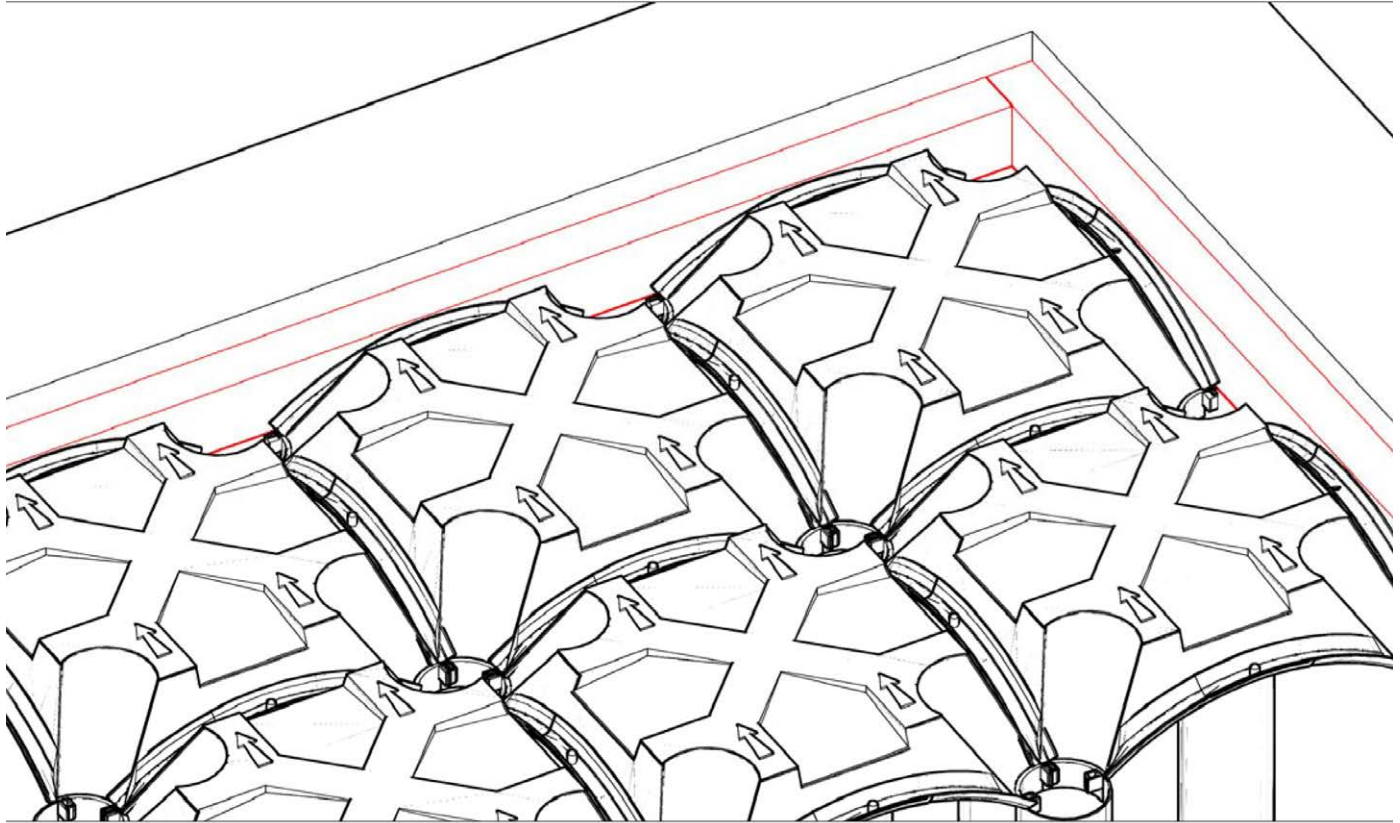

NOTE: If, in each of the 3 cases, there are any discontinuity points between the formwork and the tub edge, it is possible to close the holes using polyurethane foams.

OPERATION N°4: lay the electrowelded wire mesh and additional armour rods in the piles.

If you want the mesh to be lifted from the formwork, make sure that the spacers above the formwork are available before installation. The needles must be long enough to reach the bottom of the pipe and must be capable of being connected to the welded wire mesh.

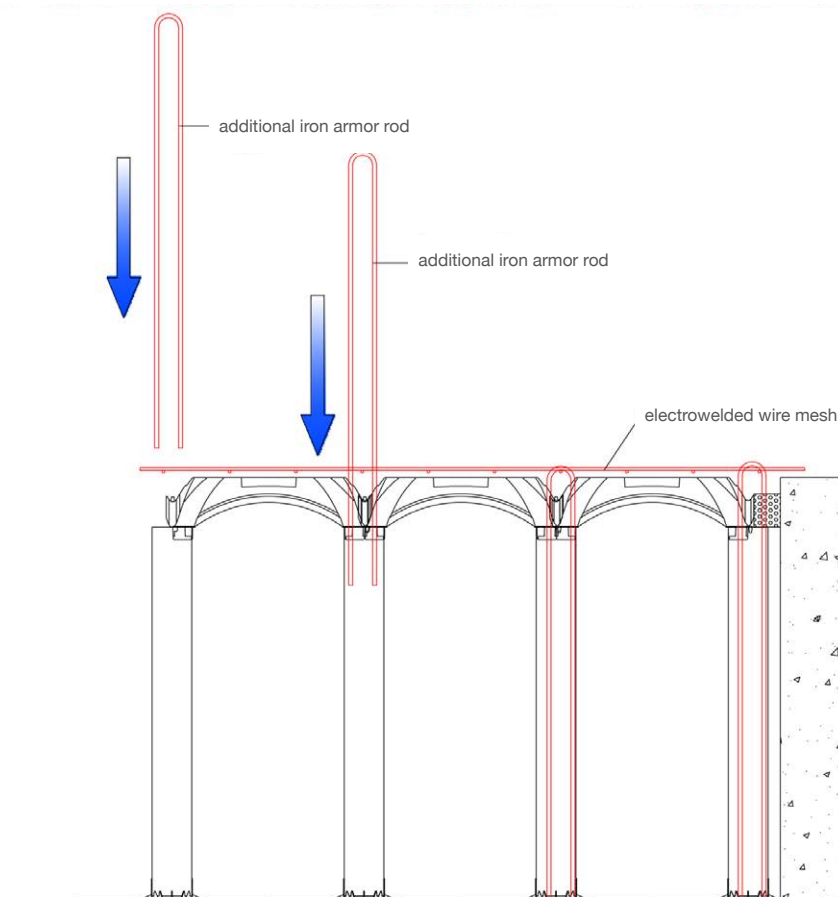
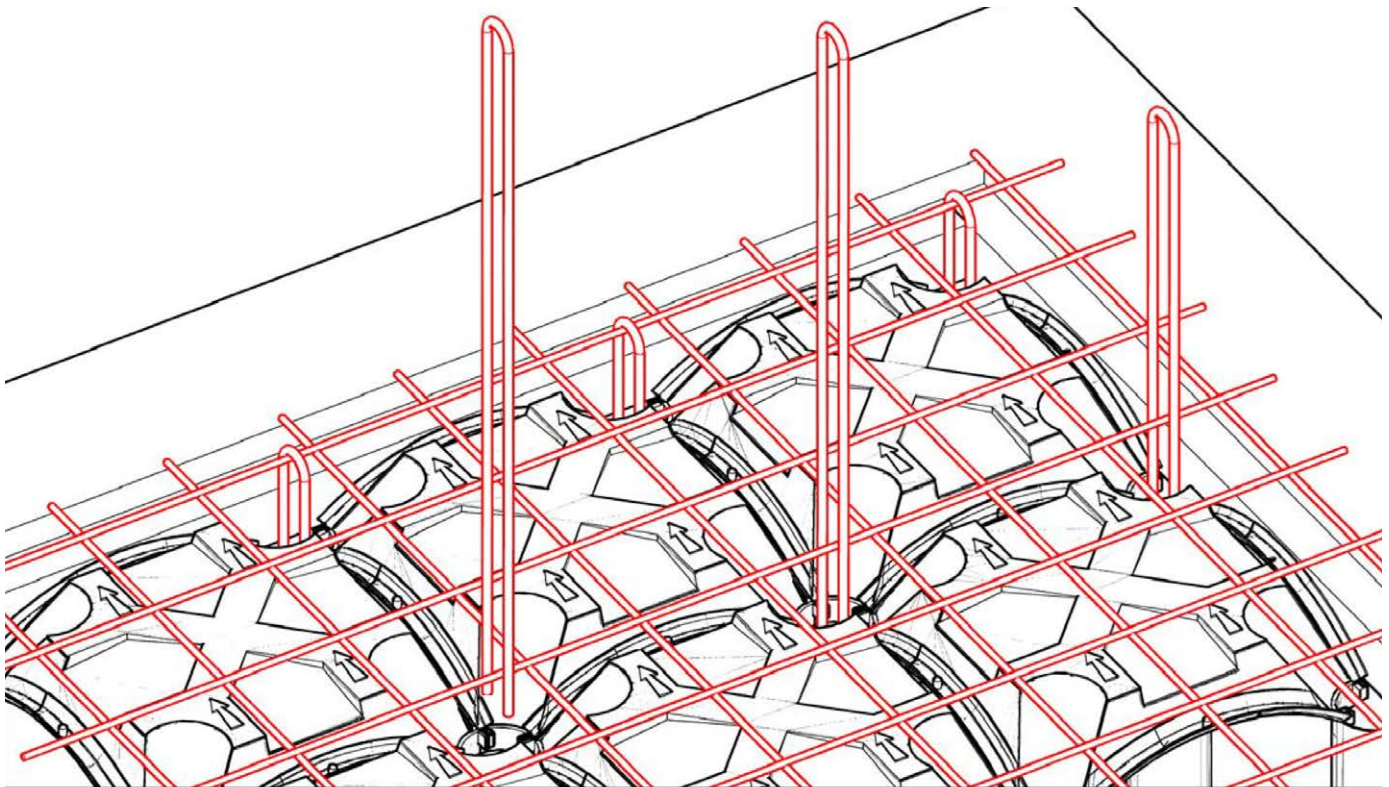

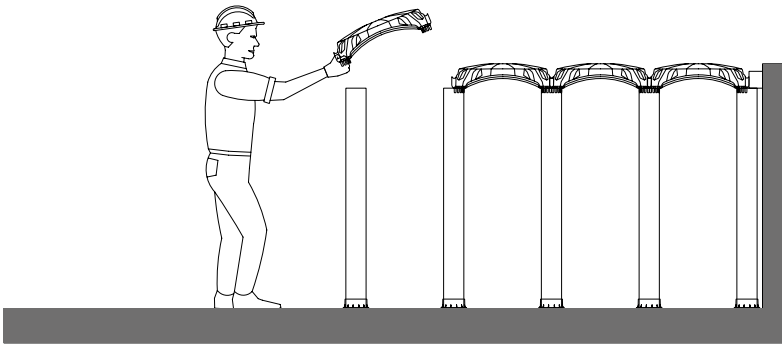

For safety reasons the assembly of the platform must start from the ground, where the height of the New Elevator formwork permits it, or with the aid of the scaffolding.

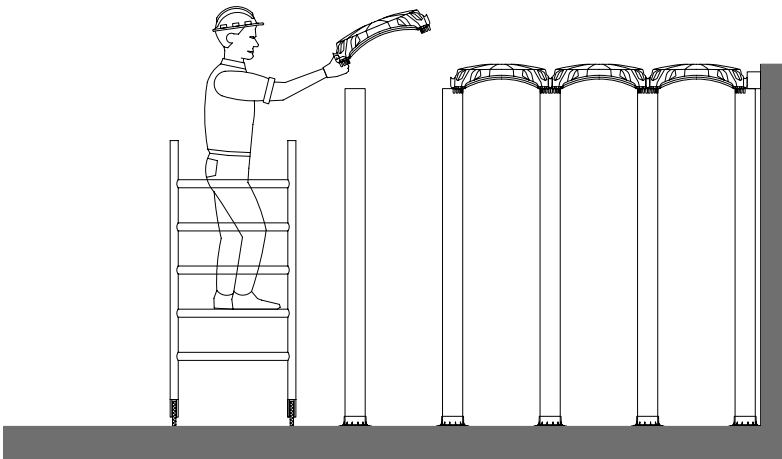

For safety reasons the assembly of the platform must start from the ground, where the height of the New Elevator formwork permits it, or with the aid of the scaffolding.

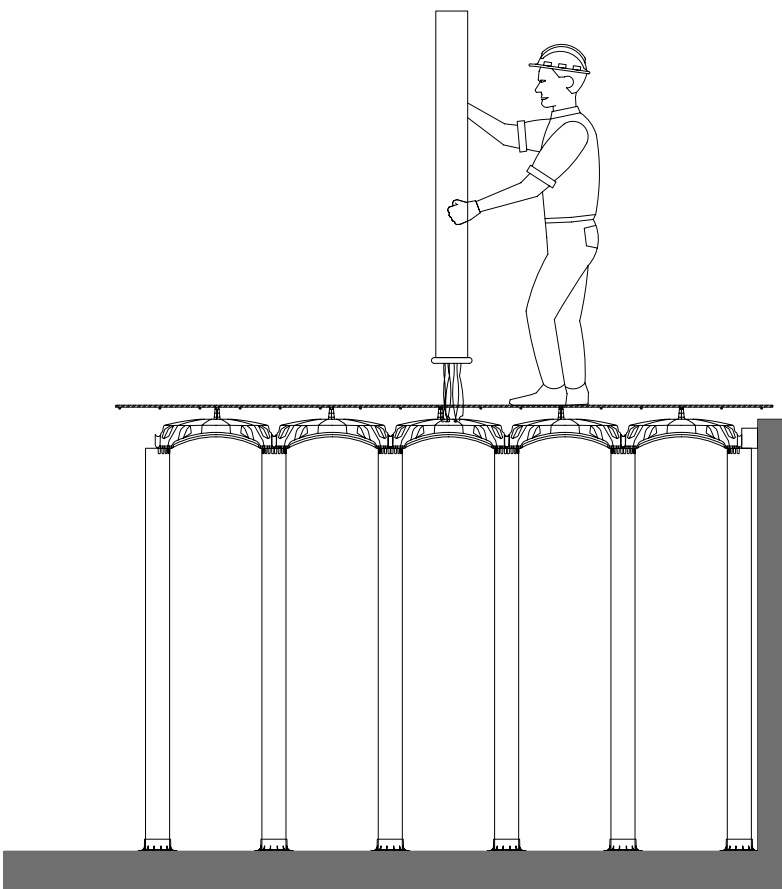

Use concrete having adequate characteristics (concrete class C20/25 at least, diameter of aggregates proper to avoid segregation).
Respect ordinary concrete casting prescriptions. Execution of concrete casting filling New Elevator pipes first and then covering the formwork till quote of project.



CAREFUL: New Elevator system 58 x 58 cm allows to cast a max thickness of the slab of 15 cm. For thicker slabs it is necessary to order special formworks (which will be delivered with a proper declaration), prop adequately or realize two separated castings.

CASTING INSTRUCTIONS



WARNING: plastic material could be heavily affected by high temperatures that can change his mechanic characteristics. Please in the warm season or in case of hot weather provide the cast of concrete in early morning / late afternoon / night or keep the formworks wet in order to maintain low the temperature of the material.

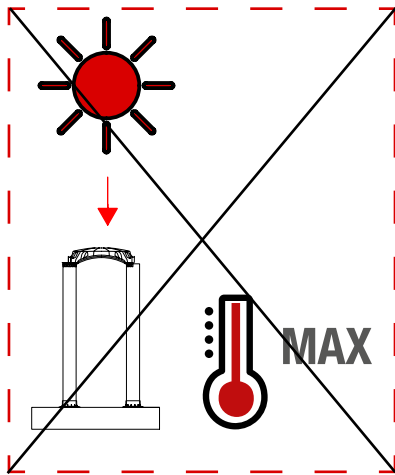

NO!

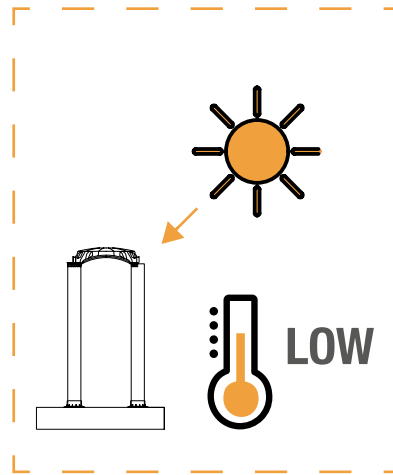

YES!

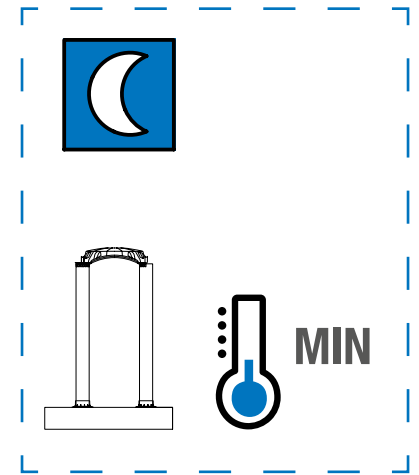

YES!

CASTING INSTRUCTIONS:

Start filling the tubes. Don't vibrate directly in the tube but pose the tool on the rebars. The correct granulometry shall be choose in function of the diameter of the bars provided inside the tubes. In case of height of tubes above 300 cm, cast a first layer of max 300 cm and complete the filling after the time of first setting of the concrete*.

Cast the top slab for max thickness of 150 mm and complete after the time of first setting of the concrete.

Assure a correct vibration of the concrete. Finish the final surface as a traditional slab.

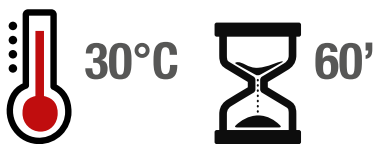

Concrete setting time is function of the air temperature. A rough indication is 60' at 30°C, 120' at 18°C. 240' at 0°C. Please follow the prescriptions of concrete supplier.

*The limit height is calculated by Mariotte formula: $H_{lim} = (2 \cdot S \cdot \sigma_{adm}) / (D \cdot \gamma)$

Where:

H_{lim} is the max tube height allowed to fill in one cast

D is the diameter of the tube

S is the thickness of the tube

γ is the density of the concrete

σ_{adm} is the yield strength of the plastic of the tube: 16 MPa

Please, in case of tubes supplier different to Spider-Plast, recalculate H_{lim} with the correct value of the tube used.



Geoplast S.p.A.

Via Martiri della Libertà, 6/8
35010 Grantorto (PD) - Italy

Tel +39 049 9490289
Fax +39 049 9494028

Geoplast@Geoplastglobal.com

GeoplastGlobal.com



rev.001 07/2020